

APOLLO LUNAR MODULE LANDING STRATEGY

Donald C. Cheatham
Assistant Chief for
Engineering and Development
Guidance and Control Division

Floyd V. Bennett
Assistant Chief
Theoretical Mechanics Branch
Guidance and Control Division

APOLLO LM LANDING STRATEGY

INTRODUCTION

STRATEGY CONSIDERATIONS

Spacecraft Systems

Guidance and Control System

Landing Radar System

IM Window System

Descent Propulsion System

Mission Landing Position Requirement

POWERED DESCENT DESIGN

Braking Phase

Objectives and Constraints

Ignition Logic

Guidance with Limited Throttle

Landing Radar Updating

Delta V Budget

Descent Guidance Monitoring

Summary of Braking Phase

Final Approach Phase

Objectives and Constraints

Determination of Hi-gate

Parameter Tradeoffs

Redesignation Footprint

Landing Point Designator Utilization

Delta V Budget

Summary of Final Approach Phase

Landing Phase

Objectives and Constraints

Nominal Trajectory

Delta V Budget

LUNAR LANDING TOUCHDOWN CONTROL

Objective and Constraints - Modes of control

Sequence of events

Descent engine shut-off

Manual control of landing velocities

Automatic control of landing velocities

ABORT AFTER TOUCHDOWN

SUMMARY

APOLLO LUNAR MODULE LANDING STRATEGY

1.0 INTRODUCTION

The landing of the Lunar Module (LM) upon the surface of the moon will be the climax of the Apollo mission, although the importance of the return phases is not to be de-emphasized. The LM landing approach will be the first time that the complete LM system will have been operated in the lunar environment. This also will be man's initial face-to-face encounter with the exact nature of the terrain in the landing area and of the problems of visibility as they may affect the ability to land the LM; although, these aspects of the landing will be simulated many times in fixed-based simulators and partial preflight simulators. These simulations are extremely important in the preparations for the mission; but only after the mission is completed will it be known how adequate the simulations have been.

Considering the entire LM descent after separation from the Command Module in lunar orbit, a theoretical landing maneuver could consist of a Hohmann transfer impulse on the back side of the moon with a delta V, or change in velocity, of 109 ft/sec, followed 180° later by an impulsive velocity change of about 5622 ft/sec as the LM approaches the lunar surface, as illustrated in figure 1. The flight path angle in the final portion of the approach would be zero degrees. Such a theoretical approach would require infinite thrust-to-weight ratio by the descent engine. This, of course, is an impossible and impractical approach. A finite thrust-to-weight ratio of the descent engine must be used and the approach path must account for lunar terrain variations and uncertainties in the guidance system. Since lunar terrain variations of as much as + 20,000 ft. could be expected, and, also, uncertainties in the value of the lunar reference radius, coupled with guidance dispersions, could add another 15,000 ft. to the uncertainty, a conservative safe value of 50,000 ft. was chosen as a pericynthion altitude. From a performance standpoint, the choice of 50,000 ft. as opposed to either 40,000 or 60,000 ft. was quite arbitrary because the difference from the standpoint of fuel requirements was very slight, as indicated in figure 2. The initial thrust-to-weight of the LM descent engine will be about three-tenths. Combining this thrust-to-weight with a perigee altitude of 50,000 ft. leads to the descent profile, as shown in figure 3. The separation and Hohmann transfer maneuver requires slightly

less delta V due to the pericyynthion altitude increase. The powered descent portion approaching the landing area, however, requires a delta V of 5925 ft/sec, which is a considerable increase over the infinite thrust requirement. A scaled trajectory profile of this theoretical LM powered descent is shown in figure 4, indicating that the entire descent takes approximately 220 n. m. The LM velocity and attitude is shown periodically along the flight profile. This trajectory has the predominant characteristics of a low flat profile terminating with a flight path angle of about 9 degrees. An obvious feature is that the crew, considering the location of the LM window, never have the opportunity to see where they are going. They can look either directly up, or, if the LM is rotated about its thrust axis, can look down at the surface, but they are never able to see in the direction they are going. If the crew is to perform any assessment of the landing area or out-the-window safety of flight during the approach, it is obvious that the latter portion of the trajectory must be shaped so that a different attitude of the LM can be used during the approach. Shaping the trajectory away from the fuel optimum approach will result in a penalty in fuel requirements. Both the amount of time the crew will require to assess the landing area, and the range from which the landing area can be adequately assessed must be traded off against the amount of fuel involved in the penalty of the shaping. It soon becomes obvious that a strategy is needed that will trade off the system capabilities of the spacecraft and the crew capabilities against the unknowns of the lunar environment encountered during the descent from the orbit, in order to insure that proper utilization of the onboard systems can be made to greatest advantage. The development of this strategy, then, is the subject of this paper.

2.0 STRATEGY CONSIDERATIONS

The LM landing strategy can be defined as the science and art of spacecraft mission planning exercised to meet the lunar environmental problems under advantageous conditions. In order to plan strategy, the objectives, the problems to be faced, and the characteristic performance of available systems need to be well known. As indicated in figure 5, the objectives of the LM landing planning strategy are to anticipate the lunar environmental problems and to plan the landing approach so that the combined spacecraft systems, including the crew, will most effectively improve the probability of attaining a safe landing. The major factors that must be considered in this strategy are the problems brought about by the

orbital mechanics of the landing maneuver, the limitations of the spacecraft systems (including limitations in fuel capacity and payload capability), and the constraints of the lunar environment (including terrain uncertainties, visibility, and determination of suitable landing positions). The orbital mechanics aspects have been discussed in the preceding section. The lunar environmental constraints will be discussed in a subsequent section. The remainder of this section is concerned with descriptions of the spacecraft systems and the mission landing position requirements. Although all of the LM systems are important to attain the lunar landing, those affecting the strategy are (a) the guidance and control system, (b) the landing radar, (c) the spacecraft window, and (d) the descent propulsion system.

Spacecraft Systems

Guidance and control system - The guidance and control system is important to the landing strategy in that it has a direct effect upon the area over which the landing may be accomplished and on the problems of landing at a desired point. The functional description and accuracies of this system have been discussed in a preceding paper. The effect of the guidance, navigation, and control system of the LM on the landing begins with navigation in the lunar orbit. The accuracy of this navigation, whether performed by the onboard system or by the Manned Space Flight Network, determines the uncertainties at the start of the powered descent. Assuming that the guidance system will be updated by landing radar to eliminate the altitude dispersions, the landing dispersions will be a function of the initial condition uncertainties brought about from lunar orbit navigation coupled with the inertial system drift during the powered descent. A summary of the guidance system capability for attaining a given landing point on the moon is presented in figure 6a and the associated assumptions in figure 6b. Both the MSFN and the spacecraft onboard navigation in lunar orbit are considered. The Apollo system specification of a landing CEP of 3000 ft. is met in either case when the inertial system performs within specification.

The 30- landing dispersion ellipses are shown in figure 7 for cases where the lunar orbit navigation was done by the MSFN and also onboard the CSM. The ellipses are quite similar with the major axis for the MSFN case being slightly shorter and the minor axis for the MSFN being slightly longer than that for the case utilizing CSM onboard navigation. A special case in which the downrange distance was allowed to

be unconstrained is also shown on figure 7. In this case the downrange or major axis of the ellipse is primarily a function of the thrust uncertainties of the fixed-throttle position of the descent engine that will be discussed subsequently. The crossrange axis is equal to that of the 30° ellipses for guidance to a specific point and is determined by the method of lunar orbit navigation.

Landing radar system - The control of the LM during the descent to the surface can be provided automatically through steering commands generated by the guidance system and also manually by the crew by inputs through an attitude controller. The primary control system stabilization utilizes digital autopilot mode of the guidance computer. Figure 8 shows the attitude thruster firing combinations to create control moments. The engines are located on an axes system rotated about the LM descent engine thrust area 45° from the spacecraft axes. They are operated as control couples for three-axis attitude control. As can be seen in figure 8, two pairs of control couples are available for each axis. The method of providing translational control while in the hovering condition is to tilt the spacecraft by means of the attitude control system. This produces a lateral component of acceleration from the descent engine thrust in the desired direction which is stopped by returning to vertical and reversed by tilting in the opposite direction. During the descent the attitude control system is also coupled to a slow moving gimbal actuator system of the descent engine to enable a means of trimming the descent engine thrust direction so that it passes through the LM center of gravity. The trimming system reduces undesirable torques from the descent engine in order to conserve RCS propellant. The LM landing radar system is important in landing strategy. As indicated earlier, it is used to eliminate the guidance system altitude dispersions and, also, the uncertainties of knowing the altitude from the lunar surface prior to beginning the descent. The LM landing radar is a 4-beam dopple system with the beam configuration shown in figure 9. The center beam measures the altitude, and the other three beams measure the three components of velocity. Two positions of the landing radar antenna provide both altitude and velocity measurements over a wide range of spacecraft attitudes. The first antenna position is tilted back from the thrust axis by approximately forty-three degrees so that the altitude beam will be nearly vertical during the early portions of the descent and, hence, will still provide accurate altitude information. As the LM approaches the landing maneuver, the antenna is physically switched to the second position making the altitude beam parallel to the X-axis of the LM. The landing radar will

begin to provide altitude measurements at an approximate altitude of 40,000 ft. These altitude measurements will be used to update the inertial system starting at an altitude of about 25,000 ft. The radar velocity updates will begin at approximately 15,000 ft. The landing radar accuracy is given in figure 10.

LM window system - The LM window, although perhaps not normally considered a system, is a very important part of the landing strategy because it is through this window that the crew must observe the landing area to confirm the adequacy of the surface for touchdown. The physical configuration of the LM window is shown in figure 11. This photograph was made from within the LM cockpit showing the left hand, or the command pilot's, window. The window is triangular in shape and skewed so that it provides maximum viewing angles for the landing approach maneuver. Although the window is not large in size, the pilot's eye position is normally very close to the window so that the angular limits provided are quite wide. These angular limits are displayed in figure 12, showing the limits as viewed from the commander's design eye position. The plot shows the azimuth and elevation variations of possible viewing limits referenced from a point where the pilot would be looking dead ahead, with respect to LM body axes (parallel to the Z-body axis), for the zero point. It is possible for the pilot to see downward at an angle of about 65° from the normal eye position and to the left side by approximately 80° . If the pilot moves his head either closer to the window, or further back, these limitations change slightly.

The guidance system is coupled with the window system through grid markings so that the pilot can observe the intended landing area by aligning his line-of-sight with the grid marking according to information displayed from the guidance system. Figure 11 in addition to showing the window system, shows the location of the Display and Keyboard, which among other things provide digital readout information from the guidance system. The procedures for utilizing these integrated systems for landing site designation and redesignation will be discussed later in this paper.

Descent propulsion system - The descent engine is an extremely important system to the design of the LM descent strategy. Initially, the descent engine was capable of being throttled over a range from 10 to 1. Design considerations, however, have made it necessary to limit the throttle capability to that shown in figure 13. This figure shows that at the start

of powered flight, there is an upper fixed position of the throttle which would nominally provide about 9700 lb. of thrust. As long as the throttle is maintained in this fixed position, thrust magnitude will vary according to the nominal solid line. At the start of the powered flight, there is expected to be approximately + 1 percent uncertainty in the thrust at this fixed-throttle setting. The uncertainty grows up to + 2 percent after approximately 300 seconds of fixed-throttle usage. The descent engine is always throttleable, in the region of 6300 lb. of thrust, to approximately 1050 lb. of thrust. The change from a fully throttleable engine in the upper region of the thrust level to a fixed-throttle position affects the guidance procedures during the initial powered descent, as will be explained later.

Mission Landing Position Requirement

Important strategy considerations are the types of requirements that are placed on the landing position, as indicated in figure 14. The first consideration is a requirement to land at any suitable point within a specified area, with the implication that the area could be quite large. Obviously, if the area is large enough, the requirements on the guidance system would be diminished considerably. The second type of requirement is that of landing at any suitable point within a reasonably small area, constrained in size primarily by the guidance dispersions. This would, of course, dictate that the size of the area chosen will be compatible with the capabilities of the guidance and navigation system. The third consideration is that of landing at a prespecified point, such as landing with 100 ft. of the position of a surveyor spacecraft, or perhaps another type of spacecraft. It is obvious that this latter consideration imposes the greatest requirements on the strategy and also the guidance system, and would require some means of establishing contact with the intended landing position during the approach. The present strategy is primarily based upon the second consideration, that of landing in areas of the size compatible with the guidance system dispersions. If, however, the landing area can be increased in size to the point that downrange position control is not of primary importance, the associated strategy is not greatly different than that for the requirement assumed because the trajectory shaping requirements would be the same for the terminal portion of the trajectory. The subsequent discussions of this paper will be based primarily upon a landing area size compatible with guidance system dispersions.

3. POWERED DESCENT DESIGN

After consideration of all the trade off's that could be identified as worthy of consideration during the LM powered descent, a three-phase trajectory design logic was chosen. The logic of this three-phase trajectory design will be discussed in the subsequent sections, but, the general logic is indicated in figure 15. The first phase following powered descent initiation at 50,000 ft. is termed the Braking Phase. This phase is terminated at what is called a Hi-gate position. The second phase is termed the Final Approach Phase, and is terminated at what is called the Lo-gate position, the start of the Landing Phase. The total trajectory covers on the order of 250 n.m. The logic of the braking phase is designed for the efficient reduction of velocity. That is, since there is no necessity for pilot visibility of the landing area in this phase, the attitudes can be chosen so that the spacecraft would have efficient utilization of descent engine thrust for reducing velocity. During the final approach phase, the trajectory is shaped to allow an attitude from which the pilot can visually acquire and assess the landing site. An additional requirement met by this phase is to provide the pilot with a view of the terrain at such a time that he can confirm the flight safety of the trajectory prior to committing to a landing. The landing phase is flown very much as a VTOL type of aircraft would be flown on the earth to allow the pilot vernier control of the position and velocities at touch-down. The attitude chosen is flown so as to provide the crew with visibility for a detailed assessment of the landing site. The scaled profile of the design descent trajectory is shown in figure 16 a) and b), and includes an indication of the spacecraft attitude at various milestones along the trajectory. The final approach and landing phases together cover only about 2 per cent of the total trajectory range, although the time spent within these phases will be about 30 per cent of the total time. The following sections will discuss in detail the logic of the design of the three phases and will summarize the delta V budget for the descent.

Braking Phase

Objectives and constraints - The objective of the braking phase, as indicated in figure 17, is to provide efficient reduction of the horizontal velocity existing at the initiation of the powered descent. During most of this phase, the altitude is high enough so that the pilot does not have to worry about the terrain variations, and he can conduct the reduction in velocity at attitudes that allow great efficiency. The major constraint of this trajectory phase is limitations imposed by the fixed-throttle-position thrust of the descent engine. It is desirable to use the maximum thrust of the descent engine as long as possible in order to provide efficient utilization of the fuel. There is, however, an initial segment

of the powered descent which is flown at reduced throttle to insure that the descent engine gimbal trim mechanism has nulled out of trim moments due to center-of-gravity offsets.

Ignition Logic - The logic for igniting the descent engine for initiation of the braking phase is as follows. First, the LM state (position and velocity) is integrated ahead in time. Next, the guidance problem for the braking phase is solved, but not implemented, continuously with the advanced LM states as initial conditions. When the guidance solution requires the level of thrust equal to the expected thrust of the fixed-throttle position, see figure 18, that solution is chosen for initiation of braking. Finally, when the LM reaches the position and velocity state that yielded the proper thrust solution, the guidance computer sends the engine on signal to the descent propulsion solution. In order to prevent large moments due to c. g. offset, the engine is ignited at the low 10 percent level, instead of maximum thrust. This level is held for some 28 seconds to trim the engine gimbal through the c.g. before increasing thrust to the maximum, or fixed-throttle, setting. This low level of thrusting is accounted for in the ignition logic.

Guidance with Limited Throttle - The general approach of the braking phase, from the standpoint of the guidance system, is to utilize the same type of guidance equations that are appropriate for the throttled phases which follow. Thus, modifications in the targeting are required to allow for the utilization of the fixed-throttle position during this phase. It is still desired to vary the state vector of the LM from its value at the start of powered descent to the state specified at the hi-gate position of the trajectory. The guidance equations would normally determine the thrust level or acceleration level and attitude required in order to make an efficient change in the state. Prior knowledge of the initial thrust-to-weight of the descent engine allows choice of initial conditions and the guidance equations to be utilized in such a way as to select a time to go for the entire phase that will use the approximate thrust-to-weight of the upper limit of the descent engine. In actual operation, the LM system during this phase will respond to commands of attitude change, but as long as the guidance system is calling for a thrust above 6300 lb., the descent engine will remain in its fixed or upper limit position. If the thrust variation of the descent engine at this fixed throttle position were known exactly, the trajectory could be preplanned to obtain the desired hi-gate state vector. In view of the uncertainties of the descent engine, however, the trajectory must be planned so that the guidance system will begin to call for thrust

levels in the region in which the descent engine can be throttled (below 6300 lbs.) prior to reaching Hi-gate position. This is to provide control over the velocities when the Hi-gate position is reached. The logic of this guidance scheme is shown in figure 19. The figure shows the profile of the trajectories as a function of range, and also a profile of the descent engine thrust, both the nominal value and that commanded by the guidance system as a function of range. The nominal thrust-to-weight case is shown first, and the trajectory is essentially preplanned by flying backward from the hi-gate position, first of all, using a thrust in the throttleable range to go back for a period of time; the period of time being determined by the possible magnitude of the uncertainty of the descent engine. This, in effect, determines the fictitious target that can be used in the guidance system in the first portion of the trajectory. The fictitious target is based upon the nominal thrust profile when the descent engine is in the fixed-thrust position. The logic of the guidance is perhaps best explained by comparing the actual value of thrust with that commanded by the guidance system, even though in the upper thrust region the descent engine is not responding to these commands.

Initially, the guidance system is targeted to a fictitious target upstream of the hi-gate state. The nominal thrust-to-weight variation follows the solid line, and the guidance system computes the commanded variation of thrust-to-weight shown on the figure. At an intermediate position, the guidance targeting is switched from that of the fictitious target to that of the hi-gate target. The discontinuity seen in the commanded position has no effect on the system, since, in this region, the descent engine throttle is not responding to the guidance system. If the thrust-to-weight does remain nominal, the commanded thrust-to-weight magnitude will gradually decrease until it is within the region in which the descent engine can be throttled. This will nominally occur at the fictitious target position. The guidance system then has a number of seconds, prior to the hi-gate position, to match both the velocity and the position desired at hi-gate. From hi-gate on, the commanded thrust will be at or below the maximum in the throttleable range. Figure 20 illustrates the thrust profiles (commanded and actual) for low and high thrust-to-weight ratios. In the case of the low thrust-to-weight ratio where the actual value of the thrust is below that of the expected nominal, it is seen that the initial commanded thrust has the same type of variation as the nominal, prior to the switchover point; but, after the switchover point, there is a delay in time and range in getting down to the region where the commanded thrust reaches the throttleable region. This point, then, is only a few seconds prior to hi-gate. The

extreme low thrust-to-weight, then, would be that in which the commanded thrust would reach the throttleable region thrust exactly at the time the hi-gate position was reached. For the case where the thrust-to-weight is higher than nominal, the commanded thrust will reach the throttleable position a number of seconds prior to that for nominal thrust. This allows a much longer time to affect the desired velocity condition at the hi-gate position. This, however, means that the region prior to hi-gate is being flown at a much lower thrust-to-weight ratio for a longer period of time than would be desirable from a standpoint of fuel efficiency. This is the case that involves the greatest penalty in fuel. Figure 21 shows the delta V penalty variation due to fixed-thrust uncertainties. The left-hand scale indicates the delta V penalty, the horizontal scale shows the bias time of the fictitious target back from the hi-gate target, and the right-hand scale is the thrust-to-weight uncertainty expressed in + percentages. The figure indicates that the + 2 percent uncertainty of the descent engine will require a bias time of approximately 65 seconds and will invoke a bias delta V penalty on the order of 45 ft/sec. In effect, the 45 ft/sec. of fuel is the penalty paid for reducing the landing dispersions from that associated with the range-free type of guidance, to that in which a desired position at hi-gate is reached. The magnitude of additional variation in the landing point that would be associated with range-free type of guidance is essentially the percentage uncertainty thrust-to-weight value times the total range travel. For the case of + 2 percent average thrust uncertainty and a nominal range of 250 n. m., this results in approximately + 5 n. m. of range uncertainty which can be eliminated at the cost of 45 ft/sec. of fuel penalty.

Landing Radar Updating - The effect of landing radar (LR) updating on the guidance commands is important from the standpoint of eliminating altitude uncertainties, and the resulting changes in attitude and throttle required by the change in solution of the guidance equations. The effect of landing radar update is a continuing effect throughout the trajectory once the initial update altitude is reached; and, therefore, some aspects of the following discussions will touch on the final approach phase as well as the braking phase.

The altitude update is initiated at 25,000 ft., as determined by the primary guidance system, and is continued at each two-second interval for the remainder of the approach. Velocity updates are initiated at about 15,000 ft., when the velocity is reduced to about 1550 ft/sec. The velocity is updated a

a single component at a time, in two-second intervals (6 seconds for a complete update). The altitude updating is continued along with the velocity components. After each complete (3 components) velocity updating, an altitude update only is performed, then the velocity updating is continued. The weighting factors for LR altitude and velocity updates are illustrated in figure 22 as linear functions of the parameter being updated. These are linear approximations to optimum weighting based upon least-squares estimation.

The guidance commands for an ideal descent (no initial condition errors, no IMU errors, no LR errors, no terrain variations, no DPS uncertainties) are shown in figure 23. The trajectory presented in the figure is not the nominal design trajectory, but is adequate to illustrate the effects of landing radar update. This particular trajectory has a hi-gate altitude of 6100 ft. and a throttle period of 80 sec. prior to hi-gate. The pitch profile exhibits a slope discontinuity at the fictitious target point (TF) for throttling the engine, as shown in part (b) of the figure.

At the hi-gate target point (HG), the pitch angle undergoes the rapid pitchup to the constant attitude desired for final near constant (about 35° of the vertical). At the low-gate target (TLG, about 500 ft. altitude), the attitude begins to change (nearly linear) to satisfy the near vertical attitude desired just prior to the vertical descent target (TVD, about 100 ft. altitude), 10° off the vertical. The profile is terminated at this point.

The same trajectory has been analyzed for cases with initial condition errors, descent engine thrust uncertainties, IMU errors, landing radar errors and a typical terrain profile approaching the landing site. The terrain profile used is shown in figure 24 and is applicable for an approach to a site at $0^\circ 20' N$ latitude and $12^\circ 30' E$ longitude. Both a properly scaled profile and an expanded altitude scale profile are shown.

An example effect of the terrain, initial condition and system errors is shown in figure 25. In addition to the effect of the terrain the other initial predominant error included was an altitude uncertainty of about minus 1600 feet. This case is considered somewhat extreme in that the altitude uncertainty of -1600 feet is about a 3σ magnitude if CSM landmark type sightings have been made on the landing site and in a directive such the terrain effects are additive with the inertial system altitude uncertainty tending to accentuate the pitch angle and thrust variations from the ideal case. The time histories of pitch angle and thrust magnitude are presented in figure 25 and include the ideal case to provide a basis for comparison.

The pitch angle varies by slightly more than 10 degrees at a maximum prior to hi-gate and is about equivalent after hi-gate. The thrust level shows generally the same level of command. The pitch angle deviations are of concern because of possible effect upon landing radar operation and because of increased expenditure of descent engine propellants.

In the event that no landmark sightings near the landing site are performed in lunar orbit, large uncertainties (up to 10,000 ft. on 3 σ basis) in the braking altitude can exist. Investigations of the ability of the IR to update these large altitude uncertainties have indicated that 100 fps of additional delta V is required. Furthermore, throttle commands above 60 percent and large attitude deviations (up to 70°) occur in some instances in the throttle down region prior to hi-gate. Further investigation of this problem is proceeding.

Delta V Budget - The nominal fuel expenditure during the braking phase is 5206 ft/sec. To this an additional 15 ft/sec. is added to account for possible mission changes that would raise the CSM altitude 10 n.m. For the random thrust uncertainties of the descent engine a 3 σ random fuel expenditure of + 20 ft/sec. is budgeted. In addition, analysis has shown that navigation uncertainties in altitude, although eventually eliminated by the landing radar, will change fuel consumption by about 60 ft/sec. for a 3000 ft. uncertainty. To account for this, a 3 σ random fuel expenditure of + 60 ft/sec. has been allotted on the fuel budget.

Descent Guidance Monitoring - An important function of the crew during the braking phase is to monitor the performance of the guidance system onboard. This is done by checking the solution of the primary guidance system with the solution of position and velocity obtained from the abort guidance system. As indicated in figure 26, this is accomplished by periodic differencing of the primary and abort guidance solutions of altitude, altitude rate, and lateral velocities. The altitude rate parameter is perhaps the most significant parameter to monitor because this is the one that can lead to a trajectory that violates the flight safety considerations. Analysis has shown, however, that it will take greater than the extremes of 3 σ performance of the abort and primary guidance solutions to lead to an unsafe trajectory prior to the hi-gate position. Because the Manned Space Flight Network will be very effective in measuring the altitude rate of the spacecraft, it also will be very effective in providing an independent vote in the event that onboard differencing indicates the possibility of a guidance failure. The total procedures for this guidance monitoring are still in the formative stages and are currently being investigated in simulations conducted by the Manned Spacecraft Center.

Summary of Braking Phase - The braking phase, lasting about 450 seconds, covers some 243 nautical miles during which the velocity is reduced from 5500 ft/sec. to approximately 600 ft/sec., and the altitude from 50,000 feet to about 9,000 feet. The attitude during the phase is normally such that the thrust vector is close to being aligned with the flight path angle. In this attitude, the pilot is not able to look in the direction of the intended landing area. In the first portion of this phase, the LM could assume any desired roll attitude about the X or thrust axis. Mission planning will determine if the initial attitude will allow the crew to look down on the lunar surface to check the progress over the terrain. As the LM approaches the position at which landing radar will begin operating, the roll attitude will be such that the windows will be oriented away from the surface in order to provide a more favorable attitude for the landing radar operation and to prepare for the pitch-up maneuver at the hi-gate position that will allow a view forward to the landing area.

Final Approach Phase

Objectives and Constraints - The final approach phase is perhaps the most important phase, from the standpoint of the strategy. It is primarily in this phase that the trajectory is shaped at a cost of fuel, in order to provide the crew with visibility of the landing area. In this phase, the crew begins to be confronted with some of the possible unknowns of the lunar environment, such as the possibility of reduced visibility. The objectives of the final approach phase are enumerated in figure 27. The first objective is to provide the crew with out-the-window visibility, and to provide adequate time to assess the landing area. The second is to provide the crew with an opportunity to assess the flight safety of the trajectory before committing the continuation of the landing. And thirdly, to provide a relatively stable viewing platform in order to best accomplish the first and second objectives. In other words, maneuvering should be kept to a minimum. The primary constraints on the strategy in this phase are again the desire to keep the fuel expenditure to a minimum and the limitation of the LM window. In the event that the ascent engine must be used for abort during this approach to the surface, the difference in thrust-to-weight between the descent and ascent engines must also be considered as a constraint. The ascent engines thrust-to-weight initially is only about one-half of that of the descent engine in this phase. The altitude loss during vertical velocity nulling as a function of nominal trajectory altitude and velocity must be included in the consideration for a safe staged abort. The other constraints that must be considered are the problems of

the lighting of the lunar terrain, and its inherent contrast properties which may make it difficult for the pilot to see and assess the terrain features. The primary variables that may be traded-off during this approach phase include the pitch attitude, the altitude at which hi-gate or the transition altitude is chosen, the flight path angle of the trajectory, and the variation of look angle to the landing area (referenced to the spacecraft thrust axis). This again considers the limitation of the LM window.

Determination of HI-gate - Perhaps the first factor that must be chosen, in order to design the final approach phase, is the hi-gate altitude. Figure 28 lists the factors affecting the choice of the hi-gate altitude. The first factor is the range from which the landing area can be assessed adequately. If this were the only factor to be considered, it would of course be unwise to waste fuel to provide this ability, if the viewing range to the target landing area was so great that the detail of the area could not be observed. The second factor is the time that the crew will require to adequately assess the landing area. A third consideration is that of flight safety requirements with regard to the uncertainties of the terrain altitude considering the operating reliability of the landing radar and its ability to update the guidance system (the inertial system), and also considering the abort boundaries associated with the ascent engine (see figure 29). Preliminary estimates were made of all these factors and considering a desire to be able to get to hi-gate, even if the landing radar is not updating the guidance system, the third requirement predominates, and flight safety dictates the choice of hi-gate altitude. If further analysis of the landing radar operations indicates a high system reliability, then the flight safety requirements will be satisfied and the hi-gate altitude would be selected on the basis of the first two considerations.

The flight safety of the final approach trajectory will be largely governed by the magnitude of the uncertainties in altitude above the terrain. Figure 30 lists the present expected uncertainties. These uncertainties include that of the guidance and navigation system which considering that onboard lunar orbit navigation is accomplished, there will be an approximate 1500 ft of altitude uncertainty on a one sigma basis. If lunar navigation is conducted by the Manned Space Flight Network, the uncertainty will be approximately 500 ft less. At the present time, and largely as a result of some of the data from the Ranger spacecraft missions, there is a large uncertainty in the lunar radius magnitude, both the bias and the random uncertainties.

Both of these quantities are established as one kilometer or approximately 3200 ft, 1σ basis at this time. Lunar Surface Technology personnel have indicated that their present capability in determining the slopes in the areas of the maria is limited to an uncertainty of approximately $+3^\circ$ on a 3σ basis so this is equivalent to a 700 ft, 1σ uncertainty, considering the ranges of uncertainty of the landing position. In addition, our present mission planning allows for a terrain profile along the approach path limited to a general slope of $+2^\circ$ with local variations not to exceed +5 percent of the nominal LM trajectory altitude. This results in altitude biases of 700 to 800 ft (3σ) over the ranges of uncertainty of the landing position.

The minimum hi-gate altitude can be determined by combining the altitude 3σ uncertainties and biases previously discussed. The manner in which these factors are combined, however, depends upon the navigational updating in orbit (with CSM optics or MSFN) and during the powered descent (with LR). Results for the various combinations are given in figure 31. The first case is based upon MSFN orbit navigation and no LR updating and represents the largest hi-gate altitude, 32,600 ft. This extreme and impractical hi-gate results from the fact that no terrain updating occurs anytime during the mission; and therefore all of the uncertainties and biases are maximum.

The second case differs from the first only in that two sighting from orbit on a landmark, in the proximity of the landing site, are provided in order to update the position (radius) of the landing site. This case assumes that orbit navigation of the CSM state is accomplished by MSFN and LR updating during the powered descent is not available. The minimum hi-gate for this case is 6700 ft, a substantial reduction over case 1. This is because the landing site update eliminates the lunar radius bias and reduces the random uncertainties in radius significantly.

The third case shows a moderate increase in hi-gate altitude over case 2 due to the moderate increase in PGNCs uncertainties from onboard navigation (which includes the landing site update) as opposed to MSFN navigation. The minimum hi-gate for this case is 7500 ft.

The preceding analysis has assumed that the crew would immediately assess a collision situation and take the appropriate action. Allowing a finite time, on the order of 10 seconds, for assessing the situation, an operational hi-gate altitude satisfying crew safety without LR is approximately 9000 ft.

Parameter Trade-Offs - Considering that the hi-gate altitude requirement has been set at approximately 9000 ft, the major trade-offs that are still needed to be established include the flight path angle, the acceptable look angle to the landing area, and the time required to assess the landing area. Each trade-off may affect the state vector that is specified at hi-gate, and this change must be taken into account in the total landing descent profile planning. Figure 32 shows the penalty of fuel as a function of hi-gate altitude. The selection of about 9000 ft as the hi-gate altitude costs about 250 ft/sec of delta V. Because the LM pilot can only see down 65° from his straight ahead viewing position, it is desirable for the look angle to be greater than 25° above the thrust axis. Considering the variations in attitude that may come about through the guidance system caused by flying over variable terrain, a desired look angle of 35° has been chosen providing a margin of 10° over the lower limit of the window. The flight path angle is also important. The angle must not be too shallow in order to get the proper perspective of the landing area as it is approached, and, on the contrary, it must not be too steep, purely from the standpoint of the pilot being better able to judge the safety of the approach path. In figure 33, the delta V penalty for variations in flight path angle for various look angles is illustrated. As can be seen from the figure, the major delta V penalty is incurred for increasing the look angle. Little penalty is paid for varying the flight path angle from 10° up to 20° for a given look angle. The sum total of the trade-off is that the hi-gate altitude will be approximately 9000 ft, the look angle to the target approximately 10° above the lower limit of the window, and the flight path angle will be in the order of 13° to 15° throughout the major portion of the final approach phase.

The shaping accomplished in the final approach phase costs approximately 270 ft/sec of equivalent fuel. In order to see what this has provided, figure 34 shows a comparison of the selected trajectory with that of the fuel optimum showing the variations of horizontal and vertical velocity as a function of time to go. Figure 33 shows that the time to go from 9000 ft altitude down to the lo-gate position has been increased by approximately 45 seconds. In addition, the vertical velocity has been cut by approximately a third for equivalent altitudes; however, the primary difference shows up in the comparison of horizontal velocity at equivalent altitudes, noting that at 5000 ft the fuel optimum trajectory has a velocity of about 1000 ft/sec, whereas the selected trajectory has a horizontal velocity of about 450 ft/sec.

Redesignation Footprint - Even though an adequate perspective of the landing area and adequate viewing time are provided by the selection of the flight path angle, the line-of-sight angle, and the hi-gate altitude, it is still pertinent to determine how much of the area the pilot needs to survey. This, in turn, is a function of how much fuel the pilot will have in order to change his landing site if he decides that the point to which the guidance system is taking him is unacceptable. Assuming that it will take the pilot a few seconds to get oriented to the view in front, it appears that the maximum altitude from which he could consider a redesignation would probably be less than 8000 feet. Figure 35 shows the available footprint as a function of fuel required for this purpose. The perspective of the figure is that of looking directly from overhead the spacecraft perpendicular to the surface where the spacecraft position is at the apex of the lines. The nominal landing point, or that point to which the spacecraft is being guided by the automatic system, is the zero-zero range position. The solid contour lines are the ranges that could be reached provided that the indicated amount of fuel could be expended. For a delta V expenditure of approximately 100 ft/sec, an additional 8000 ft downrange could be obtained, and approximately 10,000 ft in either direction crossrange. The horizontal line at the bottom of the figure indicates the lower window limit, and the second line indicates the position 5° above the lower window limit. The other lines indicate the side window view limitations experienced by the pilot or command pilot, on the left. The copilot would have a similar limitation of side vision toward the direction of the pilot, therefore, only the region bounded by the inboard side window limits would be common to the field of view of both crew members.

The variation of footprint capability as the altitude is decreased during the descent is indicated in figure 36. Contours of footprint capability are shown for an expenditure of 100 ft/sec of fuel at altitudes of 8000 ft, 5000 ft, and 3000 ft. The footprint capability naturally shrinks the closer the approach is made to the landing area. However, a given budgeted amount of fuel provides an area that subtends very closely to the same angular view from the pilot's viewing position. The present strategy is based upon having a high probability that the intended landing area will be generally suitable, and, for this reason, there will be a low probability of requiring large redesignations of the landing position.

It has been assumed that a maximum capability of designating 3000 ft downrange will be required and this provision of fuel is allotted for redesignation at 5000 ft of altitude. Approximately 45 ft/sec of fuel is required for this redesignation capability. Figure 37 shows the footprint available for this fuel allotment.

The LM pilot does not have the opportunity to see the footprint as viewed here, but instead from the perspective provided by the approach flight path angle. The pilot view from the hi-gate altitude is indicated in figure 38. During this phase, the spacecraft is pitched back approximately 40° , thus, the horizon is very near the -40° elevation depression angle. The landing site is at approximately 55° depression or about 10° above the lower limit of the window. For reference purposes a 3000 ft circle has been drawn about the landing position and the landing footprint associated with a delta V of 100 ft/sec is shown.

Landing Point Designator - The pilot will know where to look to find the intended landing area, or the area which the guidance system is taking him, by information coming from the guidance system display and keyboard (DSKY). This information will be in the form of a digital readout that allows him to locate the correct grid number on the window, commonly called the landing point designator (LPD). After proper alinement of the grid, the pilot merely has to look beyond the number corresponding to the DSKY readout to find where on the lunar surface the automatic system is guiding the spacecraft. The proposed grid configuration for the landing point designator is shown in figure 39.

The process of landing point designation and redesignation is illustrated in figure 40. The guidance system always believes that it is following the correct path to the landing site. It has the capability at any time to determine the proper look angle or line-of-sight to the intended landing site. Because of orbital navigation errors and also drifts of the inertial system during the powered descent, the actual position of the spacecraft will not be the correct position. Thus, if the pilot looks along the calculated line-of-sight he would see an area different from that of the desired landing area. Should the desired landing area appear in another portion of the window, then the pilot, by taking a measurement of the angle formed by the line-of-sight readout from the guidance system and the new line-of-sight (to the desired point), can input the change in line-of-sight into the guidance computer.

will be a cooperative task between the pilot and the copilot where the copilot will read the DSKY and call out to the pilot the numbers corresponding to the landing point designator. The pilot will then orient his line-of-sight so that he can look beyond the proper number on the landing point designator and see where the guidance system is taking him. If he is not satisfied with this position, then he can instruct changes in the guidance system by incrementing his attitude hand controller. During this portion of the approach, the guidance system is flying the spacecraft automatically so that the pilot's attitude hand controller is not effective in making attitude changes. With each increment that the pilot makes in moving the hand controller in a pitching motion, there is an instruction to the guidance system to change the landing point by the equivalent of a half-degree of elevation viewing angle. Lateral changes in the landing position would be made by incrementing the hand controller to the side in a motion that would normally create rolling motion of the spacecraft. Each increment of a hand controller in this direction causes a 2° line-of-sight change laterally to the landing area. When the guidance system receives these discrete instructions it recalculates the position of the desired landing area and commands the pitch or roll attitude in combination with a throttle command required to reach the desired position. This results in a transient response from the spacecraft until the new attitude and throttle setting commands are responded to. After the transient has settled out, the copilot would normally read the DSKY again and inform the pilot what new number to look for to find the desired landing area. The pilot would then orient himself to look at this number and check to see if his instructions to the guidance system had been fully correct. If not, some refinement in landing site selection would then be made.

The response of the spacecraft to redesignations of landing position is important. For example, if the new site selected is further downrange, the spacecraft will pitch closer to the vertical and reduction in throttle will be made so that the new position will be more closely centered in the pilot's window. If, however, the site chosen is short of the original landing site, then the spacecraft would have to pitch back and increase throttle in order to slow down and obtain the new desired position. These attitude motions affect the line-of-sight and become important because of the danger of losing sight of the target. Some typical responses to changes in the landing point are shown in figure 43. The variation of the line-of-sight to the landing site (looking angle) with time from hi-gate is shown for the nominal case, a redesignation

The guidance system will then recompute the location of the desired landing area. When this occurs the guidance system, in effect, begins a period of relative navigation where the new landing point is calculated in the present reference frame and is not significantly affected by whatever inertial system or other navigational errors that may have occurred.

The accuracy with which the landing point designation or the redesignation process can be made is a function of how accurately the line-of-sight can be interpreted, or correctly displayed to the pilot.

There are several sources of redesignation errors, as indicated in figure 41. These include the variations in terrain along the approach to the landing site, the guidance dispersion effect upon altitude (provided the landing radar updating is not complete), boresight installation, the inertial measuring unit reference misalignment, and the errors of application by the spacecraft crew. The effect of the altitude errors whether from the terrain, or from the guidance system altitude uncertainties, are shown graphically in figure 42. In this case, the guidance system assumes the landing site is at the same elevation as the terrain over which the spacecraft is flying; and, therefore, determines the line-of-sight through that point. However, when the crew views this line-of-sight the intercept point with the lunar surface is at an entirely different point than the intended landing position. For flight path angles of about 14° , this ratio of downrange error to altitude error is approximately 4 to 1. Altitude errors do not affect the lateral dispersions. It is obvious that although the landing radar performs a very vital function in reducing the altitude dispersions of the guidance system, there is probability that the same landing radar function will update the inertial system with a false indication of the landing position altitude.

The errors other than the altitude type errors (the installation IMU and the pilot application errors) all tend to be biases. Preliminary testing indicates that these errors could be of the order of one-half degree. Again for typical flight path angles of about 14° this half degree of application boresight error will lead to redesignation errors downrange on the order of 800 ft for redesignations occurring in the altitude range of 5000 to 8000 ft. These downrange errors will reduce to the order of 100 ft when the redesignations are made at altitudes of 1000 ft or less. Thus, there is a trade-off with regard to the probable magnitude of the errors that vary with altitude, especially if the approach terrain is likely to have large variations of altitudes. The process of redesignation

downrange and redesignation uprange. The redesignations occur at an altitude of 5000 ft. For the nominal landing site, the line-of-sight look angle is maintained between 35° and 30° throughout the phase. For the 3000 ft long redesignation the look angle is increased over the nominal case varying between 45° and 35° (after the resulting transient response is completed). For the 3000 ft short redesignation the pitchback motion of the spacecraft causes the line-of-sight angle to the very target area to be decreased to approximately 20° initially, increasing to about 28° for a short-time interval. Thus, for this case, visibility of the landing area would be lost for a portion of time since the lower window limit is 25° . For this reason, it would be the normal procedure not to redesignate short by more than the equivalent of about 2000 ft at this altitude. At lower altitudes, shorter range redesignations should be limited to proportionally less magnitude. For crossrange redesignations, the effect on the look angle is slight for redesignations up to 3000 ft; however, the spacecraft will require a new bank attitude (which is nominally zero for in-plane redesignations). Thus, this figure does not present the total attitude response transients for the effect of site redesignations.

An important aspect of the redesignation process is the problem of how to account for the propellant fuel expenditure. There is no accurate procedure to account for this fuel other than to interrogate the guidance system for the amount of fuel remaining.

The guidance computer load is quite heavy at this time, therefore, it is probable that a rule of thumb approach may be utilized, which, in effect, informs the pilot that so many units of elevation and azimuth redesignation capability can be utilized. Sufficient conservatism can be placed on this number to insure that the pilot does not waste fuel to the extent that the landing could not be completed. At the same time, this would allow the pilot a rough assessment of whether or not the new landing area would be within the fuel budget.

Delta V Budget - The fuel expenditure during the nominal final approach phase will be an equivalent to 889 ft/sec characteristic velocity. To this number is added, for budget purposes, a bias allowance of 45 ft/sec for the landing point redesignation capability, and a 3 σ random allowance of 15 ft/sec for refinements in the landing site designation.

Summary of Final Approach Phase - The final approach phase covers about 5 1/2 nautical miles during which the altitude is decreased from 9000 ft to 500 ft, and the velocity from 600 ft/sec to 50 ft/sec. The time required normally will be about 105 seconds during which time the pilot will have a continuous view of the landing area. It is during this time that assessments of the landing area will be made, and required redesignations of the landing position to more favorable landing terrain will be accomplished.

The Landing Phase

Objectives and Constraints - The basic purpose of the landing phase is to provide a portion of flight at low velocities and at pitch attitudes close to the vertical so that the pilot can provide vernier control of the touchdown maneuver, and also to have the opportunity for detailed assessment of the area prior to the touchdown. In order to accomplish this, the trajectory is further shaped after the final approach phase. The guidance system is targeted so that the design constraints of the lo-gate position are met, but the actual target point will be at or near the position where the vertical descent begins. The final approach phase and the landing phase are then combined with regard to the manner in which the guidance system is targeted. The targeting design would satisfy the constraints of both the terminal portion of the final approach phase and the landing phase by proper selection of the targeting parameters. There will be a smooth transition from the extreme pitch-back attitude with associated with the final approach phase and the near vertical attitude of the landing phase.

In the final approach phase, the trajectory was shaped in order to pitch the attitude more toward the vertical so that the approach conditions would allow the pilot to view the landing site. The resulting pitch attitude, approximately 40° back from the vertical is, however, still quite extreme for approaching the lunar surface at low altitudes, hence, it is necessary to provide additional shaping in order to effect a more nearly vertical attitude at the termination of the total descent. Figure 44 shows a comparison of the nominal attitudes for those two phases. The objectives and constraints of the landing phase design are presented in figure 45. The first objective is to allow the crew to make the detailed assessment, and a final selection, of the exact landing point. In order to accomplish this, there will be some flexibility in the propellant budget to allow other than a rigid following of the design trajectory. This leads to objective number two, in which it is desired to allow some

maneuvering capability and adjustment of the landing point. The constraints are familiar ones including the fuel utilization, the physical limitations of the window, and in turn, the lighting and associated visibility of the surface, the visibility associated with the lighting, the actual terrain, and the possibility of blowing dust maneuvering within the desired attitude limits in order to retain the advantages of a fairly stable platform, and last, what is termed the staged abort limiting boundary. This boundary defines the circumstances under which an abort maneuver cannot be performed without the ascent stage hitting the surface. This curve is based upon a combination of vertical velocities, altitudes, and the pilot-abort-staging system reaction time.

Nominal Trajectory - The variables that are available to try to satisfy all of these constraints and objectives include variations in the approach flight path and the velocities involved, the attitude of the spacecraft, and the actual touchdown control procedures. The landing phase profile which has resulted from almost $2\frac{1}{2}$ years of simulating the maneuver is illustrated in figure 46. The lo-gate point is at an altitude of approximately 500 ft., at a position about 1200 ft back from the intended landing spot. The landing phase flight path is a continuation of the final approach phase flight path so that there is no discontinuity at the lo-gate position. At the start of this phase, the horizontal velocity is approximately 50 ft/sec and the vertical velocity is 15 ft/sec. The pitch attitude is nominally 10 to 11° throughout this phase, but rigid adherence to this pitch attitude is not a requirement. The effect of the pitch attitude is to gradually reduce the velocities as the flight path is followed in order to reach the desired position at an altitude of 100 ft from which a vertical descent can be made. Modification of this trajectory can be accomplished simply by modifying the profile of pitch attitude in order to effect a landing at slightly different points than that associated with the nominal descent path. No actual hover position is shown in the approach profile because the vertical velocity or descent rate nominally does not come to zero. The approach is a continuous maneuver in which forward and lateral velocities would be zeroed at approximately the 100 ft altitude position and the descent velocity allowed to continue at approximately 5 ft/sec. This allows a very expeditious type of landing, however, if a hover condition is desired near the 100 ft altitude mark. It is a very simple matter for the pilot to effect such a hover maneuver. The only disadvantage of the hover maneuver is the expenditure of fuel. The total maneuver from the lo-gate position will normally take approximately 80 seconds. If flown according to the profile, the descent propellant utilized will be equiva-

lent to about 390 ft/sec of characteristic velocity. During the landing approach, the pilot has good visibility of the landing position until just before the final vertical descent phase. Figure 46 also shows a nominal sequence of pilot views of a 100 ft radius circular area around the landing point. However, even during the vertical descent, the area immediately in front of and to the side of the exact landing position will be visible. The IM front landing pad is visible to the pilot. In addition to being able to observe the intended landing site, the pilot has ample view of much of the lunar surface around him so that if the original site is not suitable he can deviate to the other landing position, provided that the new landing position is obtainable with the fuel available. The basic system design will allow the entire maneuver to be conducted automatically. However, the IM handling qualities make it a satisfactory vehicle for the pilot to control manually. The satisfactory nature of the IM manual control handling qualities has been demonstrated by fixed base simulation and by flight simulation at the Flight Research Center using the Lunar Landing Research Vehicle and the Langley Research Center using the Lunar Landing Research Facility. Simulations have shown that there should be no problems involved if the pilot decides to take over from manual control at any time during the terminal portion of the final approach phase or the landing phase.

Much concern has been generated with regard to the problem of visibility during the landing approach. This factor has led to a constraint upon the sun angle at the landing site, as will be discussed by the paper on Site Selection. In the event that the pilot has some misgivings about the area on which he desires to land, the landing phase can be flexible enough to accommodate a dog-leg type maneuver that will give the pilot improved viewing perspective of the intended landing position. Manual control of this maneuver should present no problem and could be executed at the option of the pilot. At the present time, trajectory is not planned for an approach in order to maintain simplicity of trajectory design, because of the expected ease in which the maneuver could be accomplished manually should the need be present. Should, however, the dog-leg be identified as a requirement for an automatic approach, it will be incorporated.

A profile of the altitude and altitude rate of the landing phase is shown in figure 47. The altitude rate is gradually decreased to a value of about 5 ft/sec at the 100 ft altitude position for vertical descent. The descent rate of 5 ft/sec is maintained at this point in order to expedite the landing. At approximately 50 ft of altitude (+ 10 ft), the descent rate would be decreased to the design touchdown velocity of $3\frac{1}{2}$ ft/sec. It is not necessary

for this to be done at exactly 50 ft so that uncertainties in the altitude of the order of 5 to 10 ft would not significantly affect the approach design. The value of $3\frac{1}{2}$ ft/sec descent rate is then maintained all the way until contact with the surface is effected and procedures initiated for cutoff of the descent engine. The curve labeled staged-abort boundary shown in figure 47 is applicable to the situation in which the descent engine has to be cut off and the vehicle staged to abort on the ascent engine. It is obvious that this boundary must be violated prior to effecting a normal landing on the surface. However, with the current design, this boundary is avoided until the pilot is ready to commit himself to a landing so that it is only in the region of below 100 ft that he is in violation of the boundary.

Delta V Budget - A summary of the landing phase fuel budget is given in figure 48. The budget reflects allowances for several possible contingencies. For example, the pilot may wish to proceed to the landing site and spend some time inspecting it before he finally descends to the surface. This would require that the spacecraft hesitate during the approach, and the penalty involved is the amount of fuel expended. A period of 15 seconds of hover time will cost about 80 ft/sec of fuel equivalent. There is also the possibility that the performance of the landing radar may be doubtful, in which case the spacecraft crew might want to hover in order to visually observe and null out the velocities. It has been found by means of flight tests in a helicopter, that velocities can be nulled in this manner within 1 ft/sec after less than 15 seconds of hover time (another 80 ft/sec of fuel expenditure). It would be possible to update the inertial system in this manner and allow the spacecraft to proceed and land on the surface with degraded landing radar performance during the final portion of the descent. If there are errors in the radar vertical velocity, there will be a direct effect upon the time required to complete descent and a random ± 65 ft/sec of equivalent fuel has been allotted in the fuel budget. Another descent engine fuel contingency that must be accounted for is the possible variations in the pilot control technique including the deviations from the planned flight profile the pilot might employ. Simulation experience has indicated a need for an average addition of 80 ft/sec of fuel and a random ± 100 ft/sec. It is noteworthy that only 30 seconds of hover time has been budgeted and that for specifically designated purposes.

Fuel Budget Summary

A summary of the total IM descent fuel budget is given in figure 49. The budget is divided into that required by the baseline trajectory requirement totaling 6582 ft/sec, and items, described as contingencies, totaling 353 ft/sec mean requirement with an additional ± 143 ft/sec random requirement. This leads to a total 7050. The inclusion of the RSS random contingencies as a fuel requirement is considered a conservative approach in that each of the random contingencies could lead to a fuel savings as well as a fuel expenditure. The present tankage would provide up to 7332 ft/sec of fuel or about 282 ft/sec more than the budget. Thus, the possibility of additional landing flexibility can be provided by fuel tanks, or in the interest of weight savings, some off-loading of fuel can be considered. The addition flexibility is equivalent to a hover time of about one minute or to additional downrange landing redesignation capability of almost 20,000 feet for a redesignation at 8,000 ft altitude.

The fuel budget summary is presented in figure 50b as a How-Goes-It plot of the expenditure of fuel both in equivalent characteristic velocity and pounds as a function of time and events during the descent. The solid line give the baseline trajectory and results in a fuel remaining of 778 ft/sec at touchdown. Adding the utilization of all of the budgeted contingency mean values of fuel is represented by the dashed line. When these contingencies are utilized the time basis of the plot will be incorrect, particularly for the time between Lo-Gate and Touchdown. The total time could extend to as much as $12\frac{1}{2}$ minutes (735 seconds) in the event that all of the contingency fuel were utilized for hovering over the landing site.

3.0 LUNAR LANDING TOUCHDOWN CONTROL, AUTOMATIC AND MANUAL

Perhaps the most important single operation in the lunar landing mission is the actual touchdown maneuver. It is during this maneuver that the uncertainties of the lunar surface become a real problem. A recommended procedure for controlling the approach has been developed. This procedure, developed partly through simulation, involves reaching a position at about 100 ft above the landing site and descending vertically to the lunar surface, as previously described. During the vertical descent, the lateral velocities are nulled and the vertical velocity controlled to a prescribed value until the descent engine is cut off just prior to touchdown. The procedures for effecting descent engine shutdown will be discussed in detail.

There are two control modes by which the landing operation can be performed, as indicated in figure 51. The first is completely automatic. In this mode, while the pilot may have used the landing point designator to select the touchdown point, he is not active in the actual control loop. The second mode is manual, but is aided by automatic control loops, that is, the pilot has taken over direct control but he has stabilization loops to provide favorable control response. In addition, the manual mode normally will be used in conjunction with a rate-of-descent, command mode to further aid the pilot in control of the touchdown velocities. Within the manual landing mode, the pilot has two options; (1) land visually, which would require that there be no visual obscuration as might come from dust or lunar lighting constraints, or (2) because of such obscurations he would control the landing through reference to flight instruments. Because of the expected good handling qualities of the IM, the manual visual mode should be very similar to flight of a VTOL aircraft here on earth. No landing attitude or velocity control problem is anticipated and the control should be within one foot per second lateral velocities. Manual-instrument mode of control does have sources of error, however, that may degrade control and those that have been considered include the following: control system response, landing radar velocity measurement, landing radar altitude measurement, IMU accelerometer bias, IMU misalignment, display system for manual only, the pilot, for manual only, and the center-of-gravity (c.g.) position. Several of these parameters are listed in figure 51 as being of prime importance.

In considering the control of the landing, emphasis has been placed on the method of timing of shutting off the descent engine. Because of possible unsymmetrical nozzle failure due to shock ingestion and a desire to limit erosion of the landing surface, an operating constraint of having the descent engine off at touchdown has been accepted. Probable errors in altitude information from either the inertial system or from the landing radar preclude the use of this information for the engine cut-off function, even though the accuracy may be of the order of five feet, because of the deleterious effect on touchdown vertical velocities. The need for an accurate, discrete indication of the proper altitude to cut the descent engine off led to the adoption of probes extending beneath the landing pads rigged to cause a light in the cockpit to turn on upon probe contact with the lunar surface. The light-on signal informs the pilot that the proper altitude has been reached for engine cutoff. The probe length must be determined from a consideration of delay times in pilot response, descent engine shutoff valve closures, and tail-off and the nominal descent velocities. The sequence of events is shown in figure 52.

The variation of descent rate at touchdown as a function of descent rate at probe contact is shown in figure 53, and includes the effect of pilot reaction time. The curves are representative of a 53-inch foot probe being used, coupled with a 0.25 second total engine shutoff delay time. This engine delay time includes that time required for the electronic signal to be generated, the shutoff valves to close, and the thrust tail-off to be essentially completed. The heavy dashed line on the chart going up on a 45 degree angle indicated a combination of descent rate at probe contact, plus system delay and pilot reaction times, that would cause the engine to still be on at touchdown. If the desired final rate of descent has been achieved, up to 1.0 second pilot delay time can be tolerated and still have the descent engine off at touchdown. As shown in figure 53, the actual touchdown velocity is just slightly more than the descent rate at probe contact, or about four feet per second. Faster reaction time would increase the final touchdown velocity, but not beyond present landing gear impact limit. If manual control allowed a slightly higher than desired final descent rate, and radar errors at the time of final update also allowed a slightly higher descent rate, these compounded increases might yield descent rates on the order of 5 to 6 ft/sec. These increased rates coupled with the 0.6 second reaction time would mean not meeting the criteria of having the descent engine off at touchdown. One solution for this situation would be to extend the probes to allow more leeway in pilot reaction time. However, the advantages of longer probes must be traded off against a probable decrease in reliability and an increased probability of touching down with greater than acceptable vertical velocities. A simulation study of this maneuver with the pilot cutoff of the descent engine showed that pilot reaction times averaged about 0.3 seconds, as shown in figure 54.

Pilot-in-the-loop and automatic control simulation studies have been conducted of the landing control maneuver. The pilot-in-the-loop studies were made using a simulated LM cockpit including all the control actuators (attitude, throttle and descent engine cutoff). The simulation included the major sources of system errors, such as platform misalignment, accelerometer bias, instrument display resolution, center-of-gravity offsets, and landing radar errors. The landing radar errors are a prime factor in the touchdown control process and the models assumed for the analysis are shown in figure 55. The specification performance of the landing radar calls for each of the three components of velocity to be measured within 1.5 ft/sec on a 3 σ basis. Current predictions are that this specification will be met in lateral and forward directions and bettered by 3/4 ft/sec vertically. For a conservative analysis, the predicted performance has been degraded by a factor or two.

The simulation results of landing velocity manual control with specification performance by the landing radar are shown in figure 56. The dashed lines indicate the present design criteria for the landing gear. The 0.9, 0.99 and 0.999 probability contours are shown and are well within the design envelope. The effect of changing the length of the landing probes is to adjust the vertical velocity bias velocity approximately 1 ft/sec per foot change in probe length.

The effect of landing radar performance upon the landing velocity envelope is shown in figure 57. The 0.99 probability contours are shown for the cases of no radar errors, specification performance, predicted performance, and degraded (predicted) performance. The resulting contours show the almost direct dependence of touchdown velocity error upon the landing radar velocity performance.

The comparative results between automatic and manual control of the landing touchdown velocities are shown in figure 58. The 0.99 contours show that automatic control results in lower touchdown velocities, but the difference is much less pronounced for the degraded radar performance as compared with the predicted radar performance. The figure does not, of course, reflect the advantage that manual control provides in closer selection of the actual touchdown position in the event that the terrain is not uniformly satisfactory.

Additional analysis of these same results for the control performance for attitude and attitude rates indicated that control within the present criteria of 6 degrees and 2 degrees per second can be expected on a 3 σ probability.

4.0 ABORT AFTER TOUCHDOWN

Although analysis and simulation tests indicate a high probability that the landing touchdown maneuver will be within the landing gear design criteria, there is still an interest in the ability to abort should the landing dynamics become unstable. The ability to abort will be a function of when the need for the abort is recognized, the time required to initiate abort, the time involved in separation of the ascent stage, the thrust buildup time of the ascent stage, the attitude and the attitude rate at separation, and the control power and control rate limitations of the ascent stage.

At staging, the control power of the ascent stage is about 35 deg/sec² for pitch and roll attitude maneuvers. Under emergency manual control where the pilot deflects his attitude hand controller

hard-over, there is no attitude rate limitation. Normal manual control commands are limited to $20^{\circ}/\text{sec}$ and automatic control limited to $10^{\circ}/\text{sec}$ in pitch and $5^{\circ}/\text{sec}$ in roll. These attitude rate limitations are important from the standpoint of determining how quickly the ascent stage attitude can be returned to the vertical in the event of an impending tipover.

An analysis was made of the boundary of over-turn conditions from which a successful staged abort could be made. The results of this analysis are shown in figure 59. Two boundaries are shown; one for emergency manual attitude control which requires the pilot to put his hand controller hard over and the other for a rate limit consistent with automatic roll response ($5^{\circ}/\text{sec}$). Both boundaries apply to the conditions under which an abort action must be recognized as being required. The boundaries allow a total of 1.4 seconds for the time required for the pilot to actuate the abort control, the staging to take place, and the ascent thrust to build up to 90 percent of rated thrust.

In addition to the boundaries, there is also a line indicating the neutral stability boundary or the sets of condition under which the spacecraft would just reach the tipover balance point of about 40 degrees. The curve labeled Landing Gear Design Envelope Maximum Energy applies to the improbable, if not impossible, case where the landing was made at the corner of the velocity criteria envelope 7 ft/sec vertical and 4 ft/sec horizontal, and all of the energy was converted to rotational motion. It is, therefore, highly improbable that conditions will be encountered that lie to the right of this curve.

For the emergency manual control, the boundary indicated an abort can be made at an altitude of about 60 degrees if the rate is not greater than 10 deg/sec. This condition would take more than 4 seconds to develop after the initial contact with the lunar surface. For the other extreme of attitude rate limit ($5^{\circ}/\text{sec}$) applicable only to automatic roll attitude control, the boundary is reduced about 10 degrees in attitude.

The pilot will have indication of attitude from his window view and from the attitude instrument display (FDAI). Both of these are considered adequate sources of attitude information in the event that the spacecraft passes a 40 degree deviation from the vertical and an abort becomes necessary.

Considering the improbability of landing contact that would result in an unstable post-landing attitude and the probability that even in such an event the pilot could initiate a safe abort, there does not appear to be a requirement for an automatic abort initiation.

5.0 LEM DESCENT LOGIC FLOW

The preceding sections have described and explained the design of the LM descent strategy and the resulting trajectory design. From the pilot's standpoint there are a number of judgments and decisions that will have to be made in the period from Hi Gate to Lo Gate to touchdown. It is believed that the strategy allows a logical sequence of events and decisions and adequate time for the pilot function. This will be partly confirmed or adjustments made through extensive simulations with the LM Mission Simulators. The final confirmation will, of course, be the results of the first LM landing approach. In order to aid in the understanding of the logic and proposed sequence of decisions, a logic-flow chart has been prepared that is applicable from the Hi Gate position to landing touchdown. These charts are presented in figures 60a) and b) for the information and use of persons interested in detailed examination of the logic and in constructing the crew loading time lines. Details of these logic flow charts will not be discussed further in this paper.

6.0 SUMMARY

A LM descent strategy has been presented which is designed to take advantage of the LM system and the LM crew in order that the LM will continually be in an advantageous position to complete the lunar landing. The three phases trajectory is designed to maintain fuel expenditure efficiency, except in those regions of the trajectory where such factors as pilot assessment of the landing area require a judicious compromise of fuel efficiency.

The lunar landing strategy has considered all identified problems which might adversely affect the lunar landing and the resulting design calls for a fuel expenditure budget of 7050 ft/sec of characteristic velocity. This budget is approximately 282 ft/sec less than the current tank capacity of the LM. This margin is considered ample for dealing with presently unforeseen problems which may be identified prior to the lunar landing.

Questions and Answers

LUNAR EXCURSION MODULE DESCENT

Speaker: Donald C. Cheatham

1. Mr. Kelly - Probability plots of landing velocity show constant vertical velocity for all probabilities when horizontal velocity is zero; is this correct?

ANSWER - Mr. Kelly and Mr. Cheatham discussed the data after the meeting and resolved their differences on the presentation form.

THEORETICAL LM DESCENT

IMPULSIVE ΔV

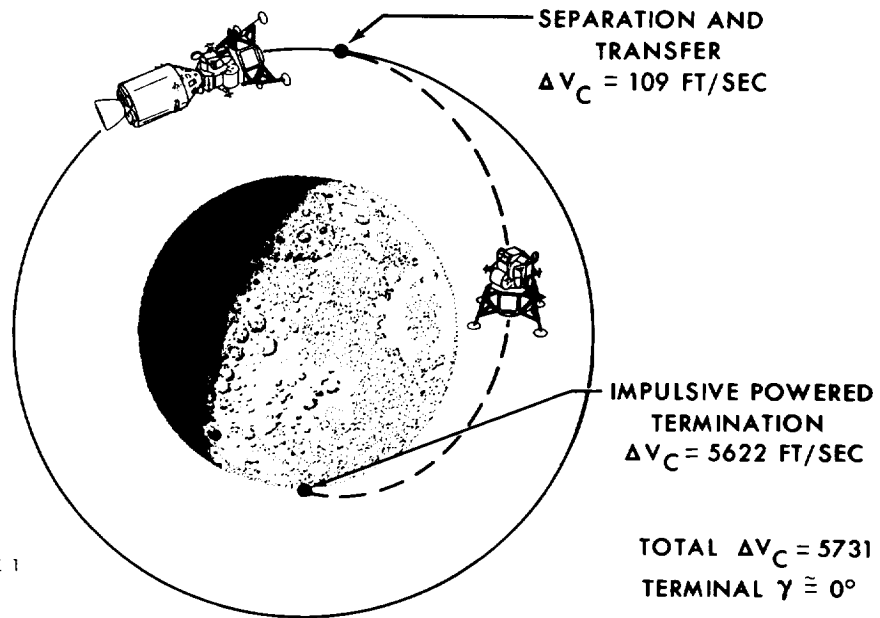

FIGURE 1

VARIATION OF POWERED-DESCENT CHARACTERISTIC VELOCITY WITH THRUST-TO-WEIGHT RATIO

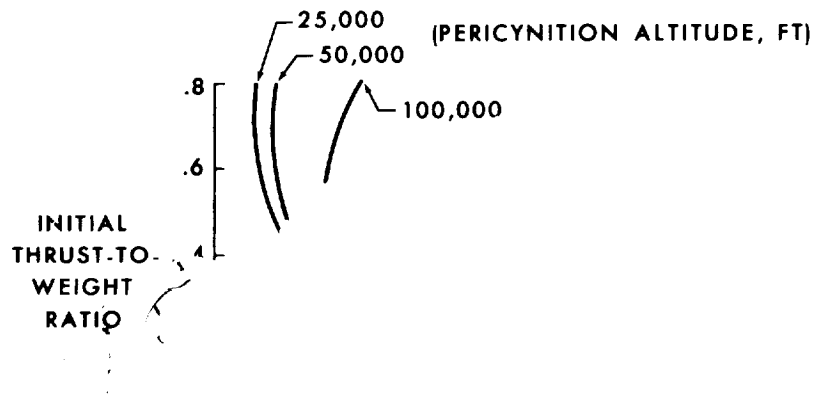

FIGURE 2

THEORETICAL OPTIMUM LM DESCENT

$(T/W_0 = .3, H_p = 50,000 \text{ FT})$

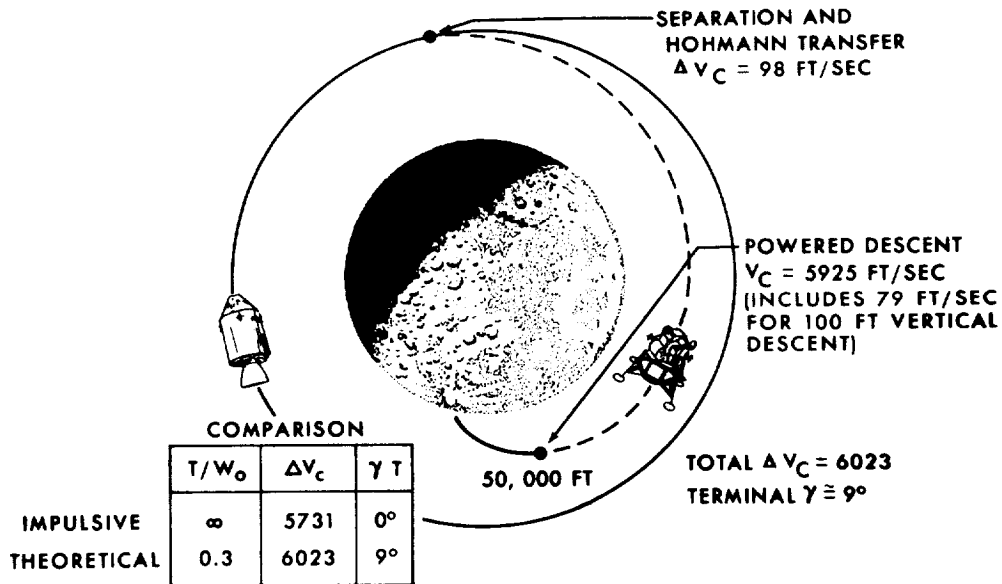
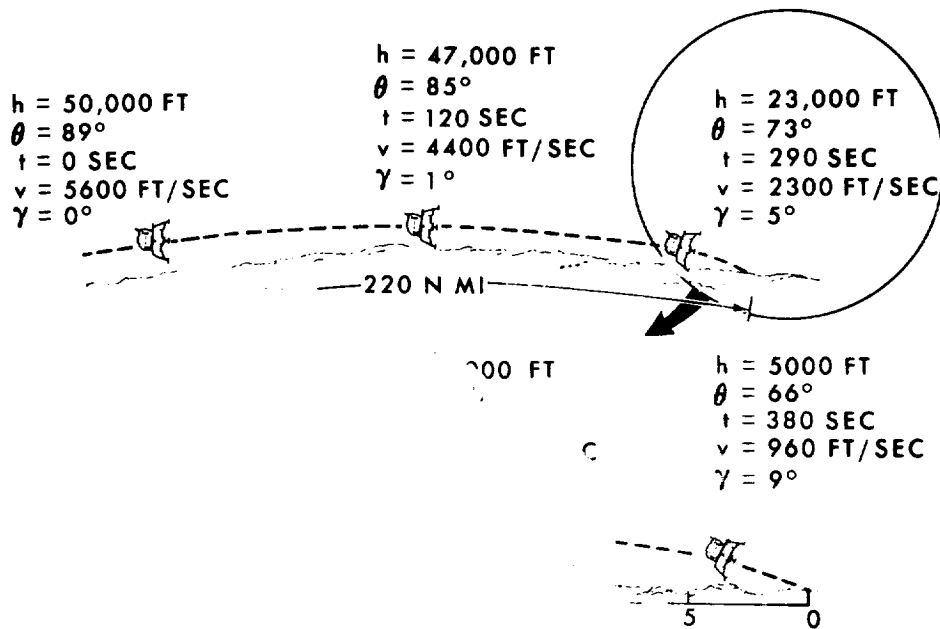

FIGURE 3

OPTIMUM POWERED DESCENT



THEORETICAL LM DESCENT

IMPULSIVE ΔV

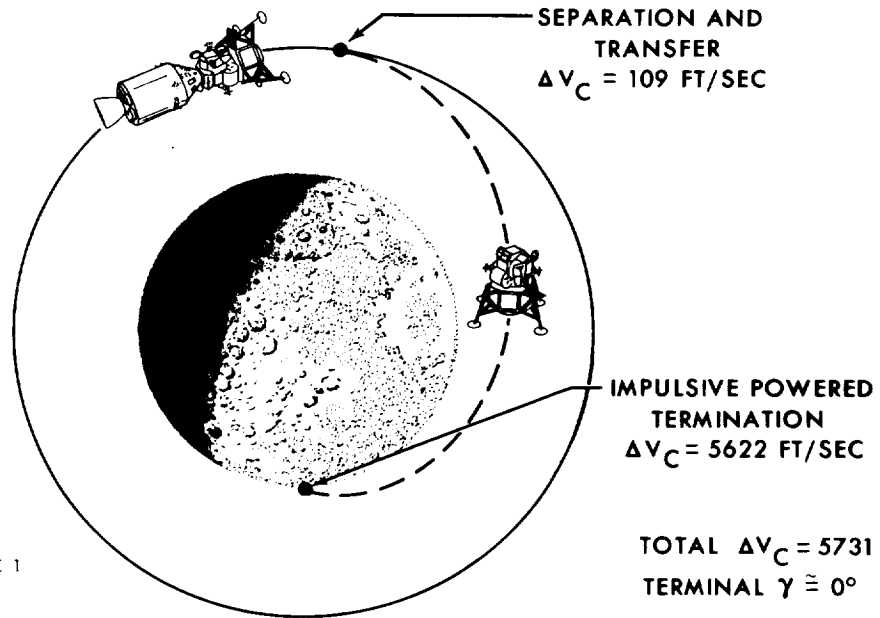

FIGURE 1

VARIATION OF POWERED-DESCENT CHARACTERISTIC VELOCITY WITH THRUST-TO-WEIGHT RATIO

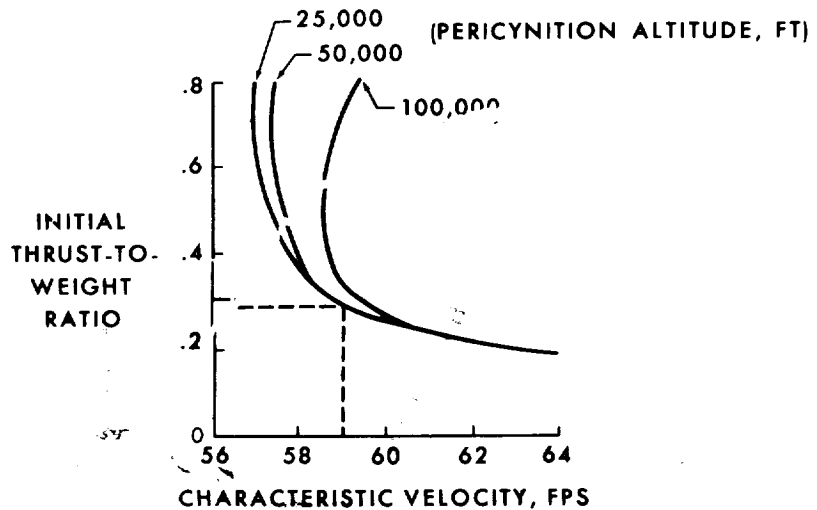

FIGURE 2

THEORETICAL OPTIMUM LM DESCENT

$(T/W_0 = .3, H_p = 50,000 \text{ FT})$

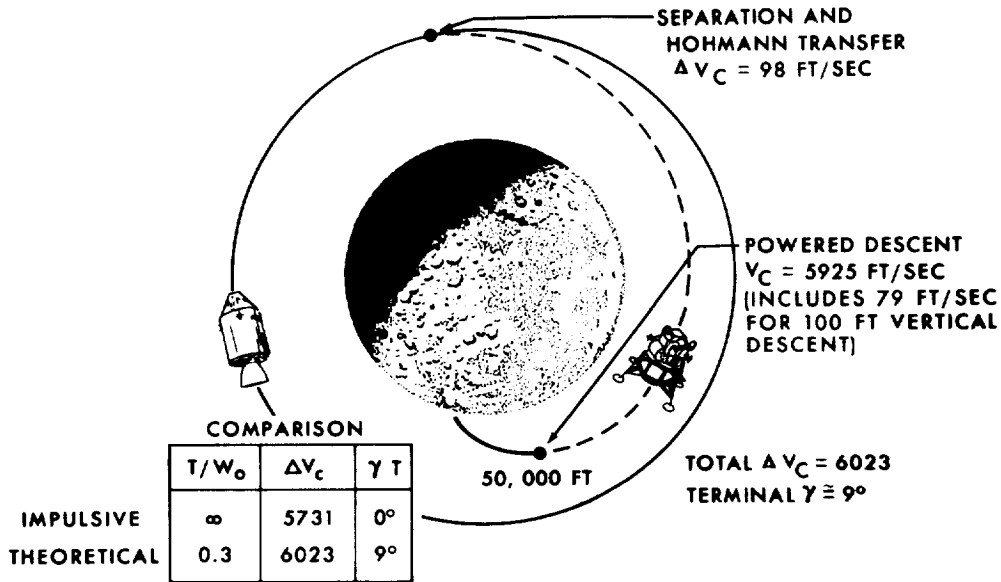

FIGURE 3

OPTIMUM POWERED DESCENT

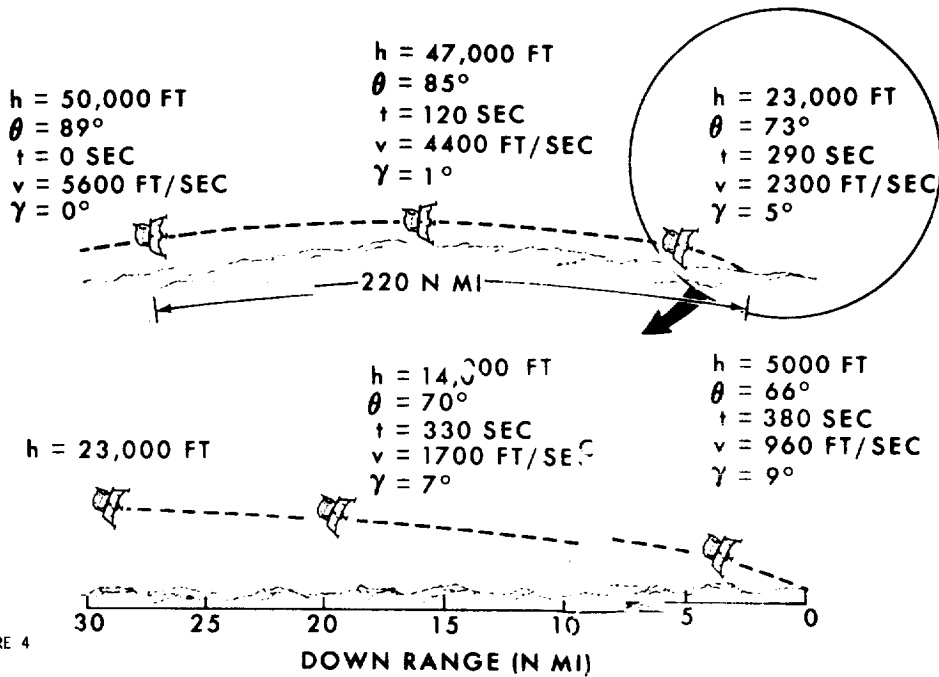

FIGURE 4

LM LANDING PLANNING STRATEGY

- OBJECTIVE
 - TO ANTICIPATE THE LUNAR ENVIRONMENT PROBLEMS AND TO PLAN THE LANDING APPROACH SO THAT THE COMBINED SPACECRAFT SYSTEMS INCLUDING THE CREW WILL MOST EFFECTIVELY IMPROVE THE PROBABILITY OF ATTAINING A SAFE LANDING

- MAJOR FACTORS
 - ORBITAL MECHANICS PROBLEMS
 - PERFORMANCE LIMITATIONS OF SPACECRAFT SYSTEMS
 - LUNAR ENVIRONMENT-VISIBILITY, TERRAIN UNCERTAINTIES, AND IRREGULARITIES

- PREDOMINANT SC SYSTEMS
 - GUIDANCE AND CONTROL
 - LANDING RADAR
 - DESCENT PROPULSION
 - SC WINDOW

FIGURE 5

LM LANDING ACCURACY AFTER THREE ORBITS

NAVIGATION PHASE CONTRIBUTION		DOWN-RANGE σ(FT)	CROSS TRACK σ(FT)	CEP (FT)	ALTITUDE σ(FT)
LM SEPARATION AND HOHMANN DESCENT		1070	60	730	540
POWERED DESCENT		260	1410	1000	1490
RSS OF THE ABOVE TWO		1100	1410	1480	1580
LUNAR ORBIT NAVIGATION	MSFN	2320	700	1750	840
	ONBOARD	2840	540	1990	1180
TOTAL ACCURACY	MSFN	2570	1570	2410	1790
	ONBOARD	3040	1510	2630	1970

FIGURE 6A

LM LANDING ACCURACY AFTER THREE ORBITS(CONT) ASSUMPTIONS & ERROR MODELS (1^o)

- LANDING SITE AT 0° LATITUDE AND 0° LONGITUDE
- MSFN UPDATE PRIOR TO LUNAR ORBIT INSERTION
- TWO LANDMARKS WITH THREE SIGHTINGS PER LANDMARK PER PASS
- LM SEPARATION FROM CSM ON THIRD ORBIT, PLATFORM ALINEMENT AT 15 MINUTES BEFORE A MANEUVER

ACCEL BIAS	.0017 FT/SEC ²	SCANNING TELESCOPE	.06 DEG
ALINEMENT ACCURACY (ACT)	.06 DEG	GYRO DRIFT	.03 DEG/HR
LANDMARK ACCURACY	7500 FT		

FIGURE 6B

LM LANDING 3σ UNCERTAINTY ELLIPSE AFTER THREE ORBITS LANDING SITE 0° LAT 0° LONG

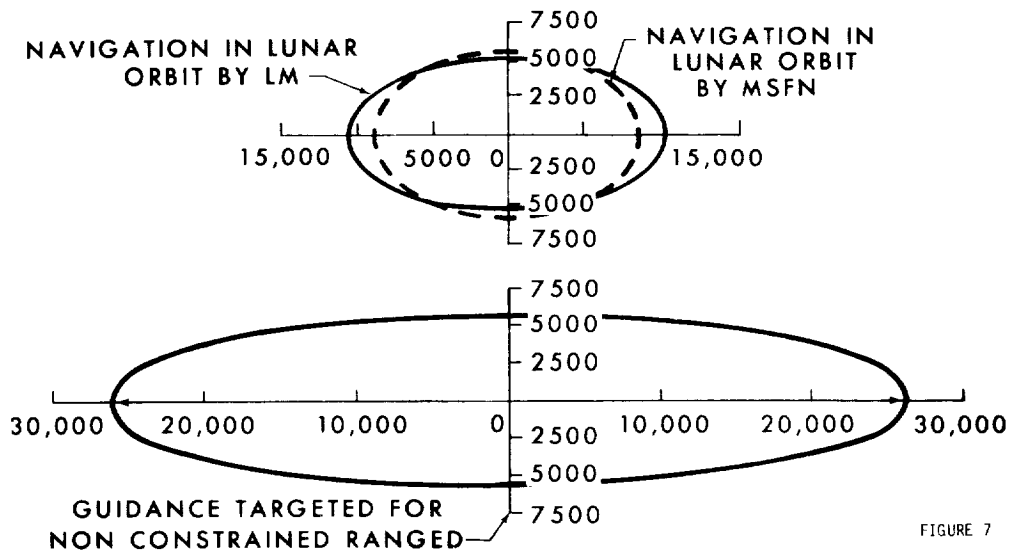
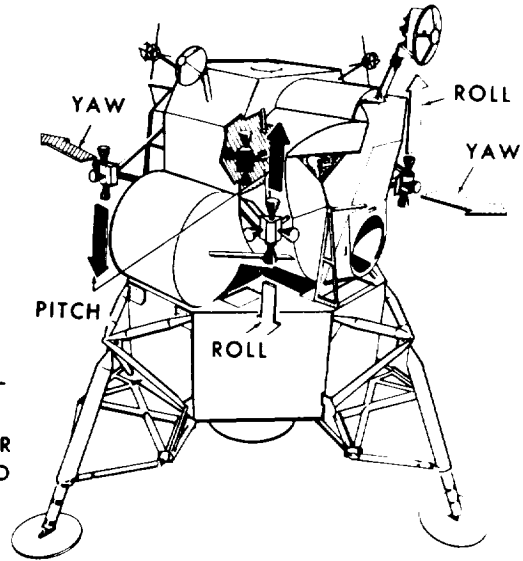

FIGURE 7

ATTITUDE CONTROL OF LM



NOTE:
 IN DESCENT THRUST CONFIGURATION MAIN ENGINE GIMBAL IS EMPLOYED FOR TRIMMING THE PITCH AND YAW MOMENT DUE TO CENTER OF GRAVITY SHIFTS

FIGURE 8

LANDING RADAR BEAM CONFIGURATION AND ANTENNA TILT ANGLES

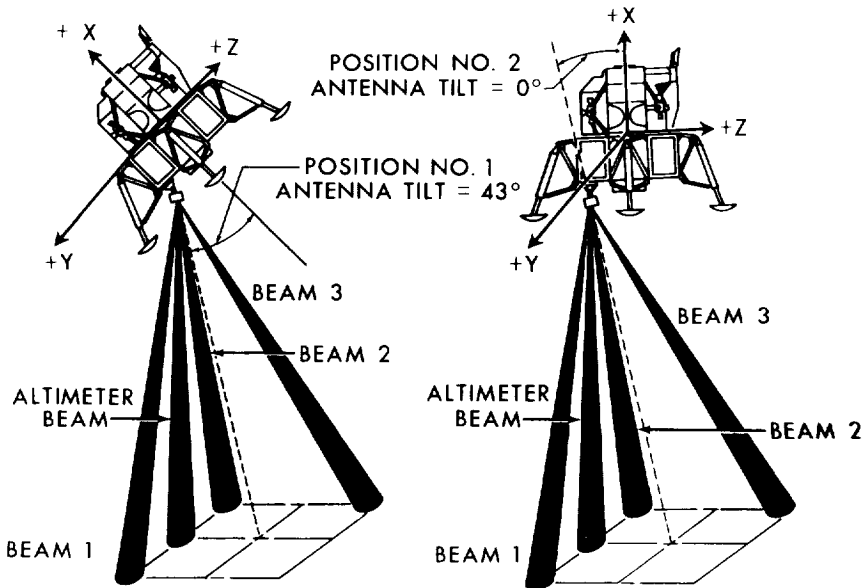

FIGURE 9

LM LANDING RADAR (3 σ) SPECIFICATION ACCURACY

ALTITUDE, FT	ACCURACY		
	RANGE TO SURFACE	V _{XA}	V _{YA} , V _{ZA}
5 - 200	1.5% + 5 FT	1.5% OR 1.5 FPS	2.0% OR 1.5 FPS
200 - 2000	1.5% + 5 FT	1.5% OR 1.5 FPS	3.5% OR 3.5 FPS
2000 - 25,000	1.5% + 5 FT	1.5% OR 1.5 FPS	2.0% OR 2.0 FPS
25,000 - 40,000	2%	N/A	N/A

FIGURE 10

LM FLIGHT CONFIGURATION

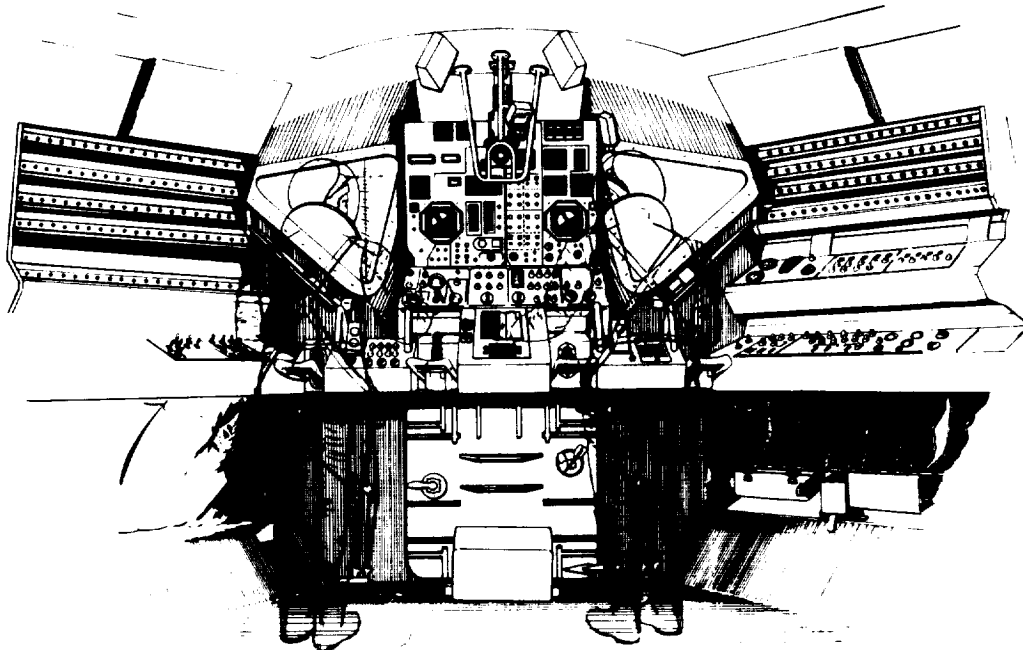

FIGURE 11

LM WINDOW VIEWING LIMITS FROM COMMANDER'S DESIGN EYE POSITION

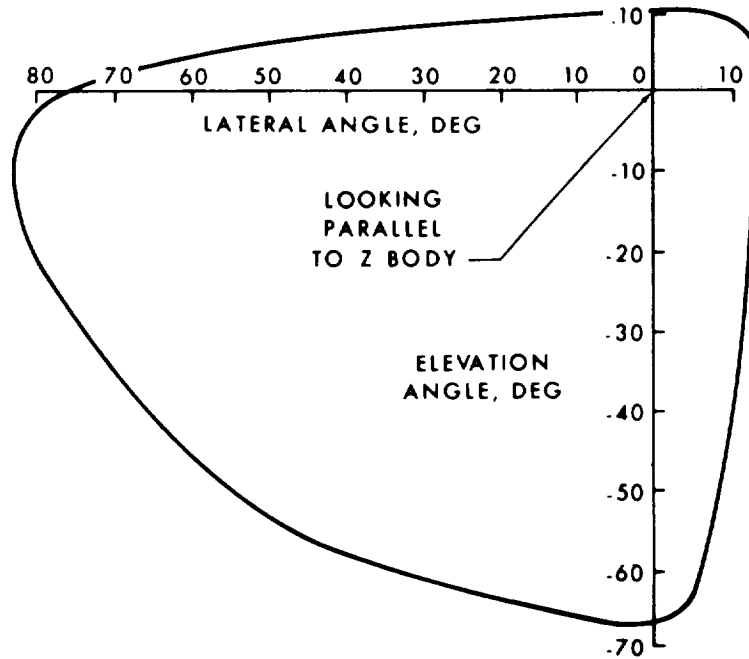

FIGURE 12

LM DESCENT ENGINE THRUST CHARACTERISTICS

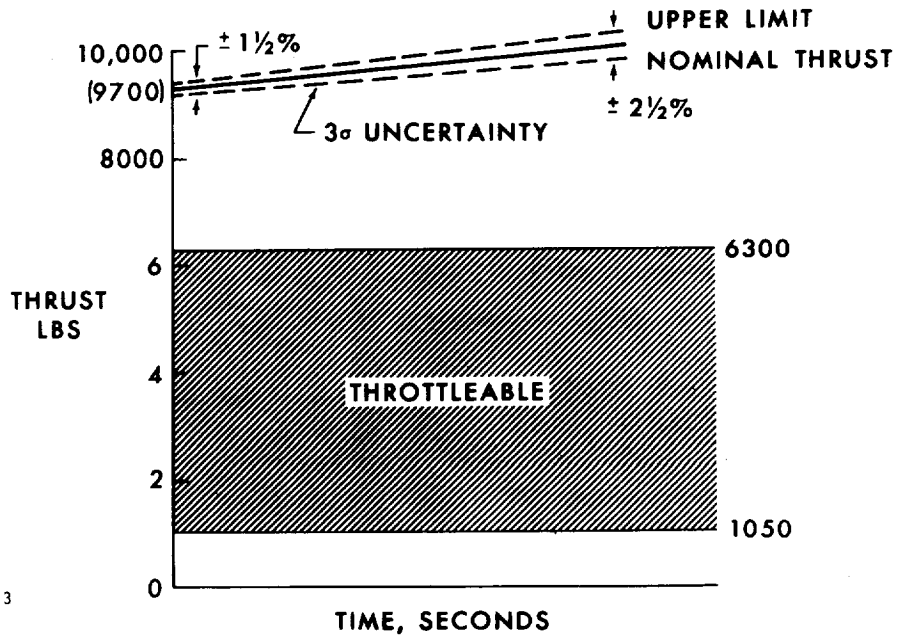

FIGURE 13

VARIATION OF LM LANDING POSITION REQUIREMENTS THAT HAVE BEEN CONSIDERED

- LANDING AT ANY SUITABLE POINT WITHIN A SPECIFIED AREA
- LANDING AT ANY SUITABLE POINT WITHIN A SMALL AREA CONSTRAINED IN SIZE PRIMARILY BY GUIDANCE DISPERSIONS*
- LANDING AT A PRESPECIFIED POINT (SUCH AS A SURVEYOR)

FIGURE 14 *PRESENT STRATEGY IS BASED UPON THIS REQUIREMENT

LM THREE-PHASED POWERED DESCENT

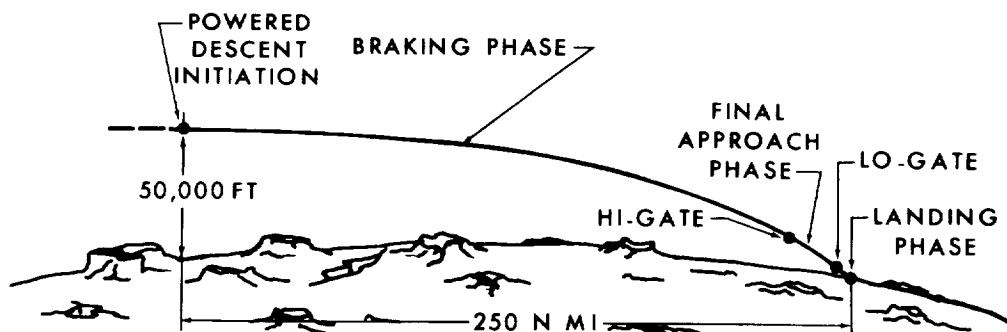

- BRAKING PHASE - ALLOWS EFFICIENT REDUCTION OF MOST OF VELOCITY
- FINAL APPROACH PHASE - ALLOWS ACQUISITION AND ASSESSMENT OF SITE AND CONFIRMATION OF FLIGHT SAFETY BY PILOT
- LANDING PHASE - ALLOWS VERNIER CONTROL OF POSITION AND VELOCITIES

FIGURE 15

LM POWERED DESCENT

		TARGET SWITCHOVER	
	MAXIMUM THROTTLE	h=43,000 FT	
ENGINE IGNITION	h=50,000 FT	$\theta=80^\circ$	LR ALTITUDE UPDATE
h=50,000 FT	$\theta=88^\circ$	T=228 SEC	h=25,000 FT
$\theta=86^\circ$	T=28 SEC	V=3385	$\theta=71^\circ$
T=0 SEC	V=5564 FT/SEC	$\gamma=-1.4^\circ$	T=328 SEC
V=5500 FT/SEC	$\gamma=-.2^\circ$		V=2164 FT/SEC
$\gamma=0^\circ$			$\gamma=-4.0^\circ$

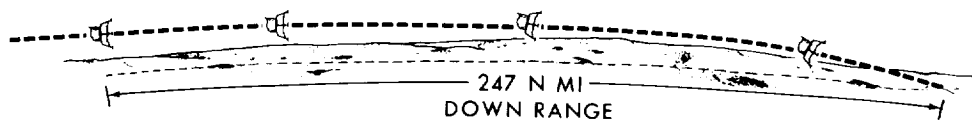

FIGURE 16A

LM POWERED DESCENT (CONT)

	FICTITIOUS TARGET	HIGH GATE	LOW GATE
	h=16,000 FT	h= 8600 FT	
LR ALTITUDE UPDATE	$\theta=66.5^\circ$	$\theta=46^\circ$	h=500 FT
h= 25,000 FT	T=400 SEC	T=454 SEC	T=558 SEC
	V=1067 FT/SEC	V=608 FT/SEC	V=52
	$\gamma=-4.0^\circ$	$\gamma=-14.5^\circ$	FT/SEC
			$\gamma=-17.0^\circ$

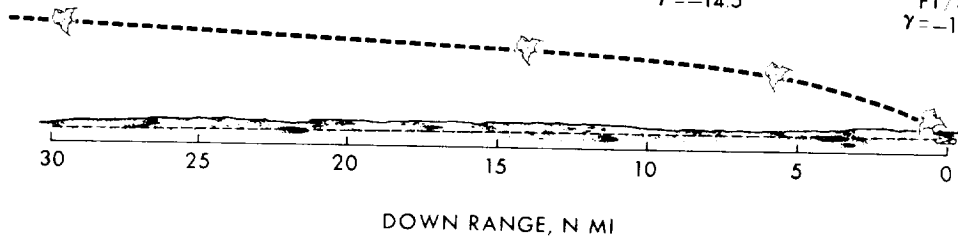

FIGURE 16B

BRAKING PHASE DESIGN

● OBJECTIVES

- REDUCE VELOCITY TO ACCEPTABLE LANDING APPROACH MAGNITUDES
- MAINTAIN EFFICIENT USE OF PROPELLANT FUEL
- REACH A PRESPECIFIED STATE VECTOR AT HI-GATE POSITION

● CONSTRAINTS

- DESCENT ENGINE IS NON-THROTTLEABLE IN MAX THRUST REGION
- MAXIMUM THRUST OF DESCENT ENGINE IS INITIALLY ≈ 9700 LBS ($T/W \approx 3$)
- FIXED THRUST UNCERTAINTIES MAY REACH $\pm 2 \frac{1}{2}\%$

FIGURE 17

POWERED DESCENT IGNITION LOGIC

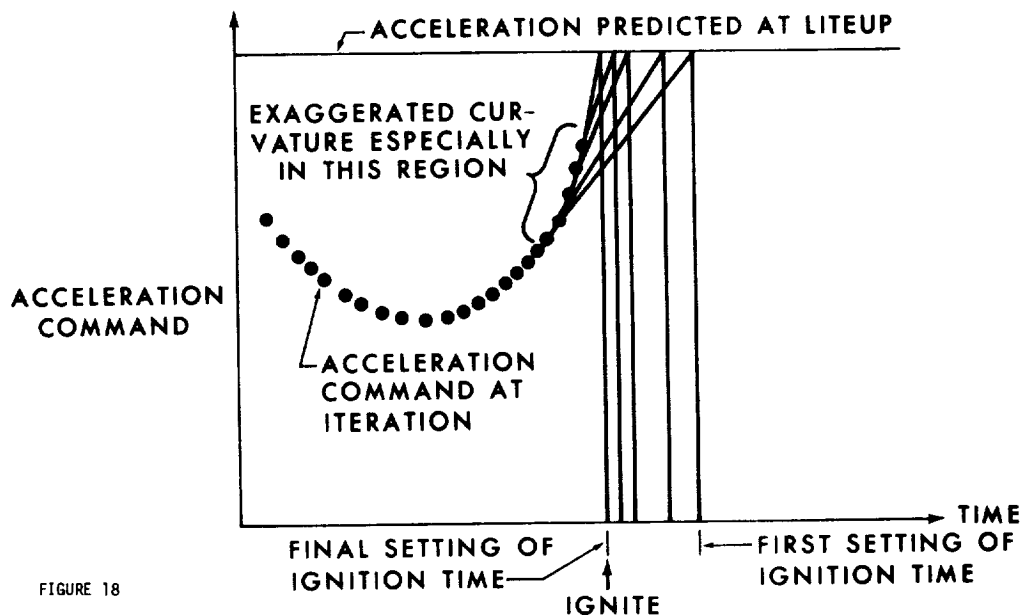

FIGURE 18

THRUST BEHAVIOR FOR LIMITED THROTTLE GUIDANCE

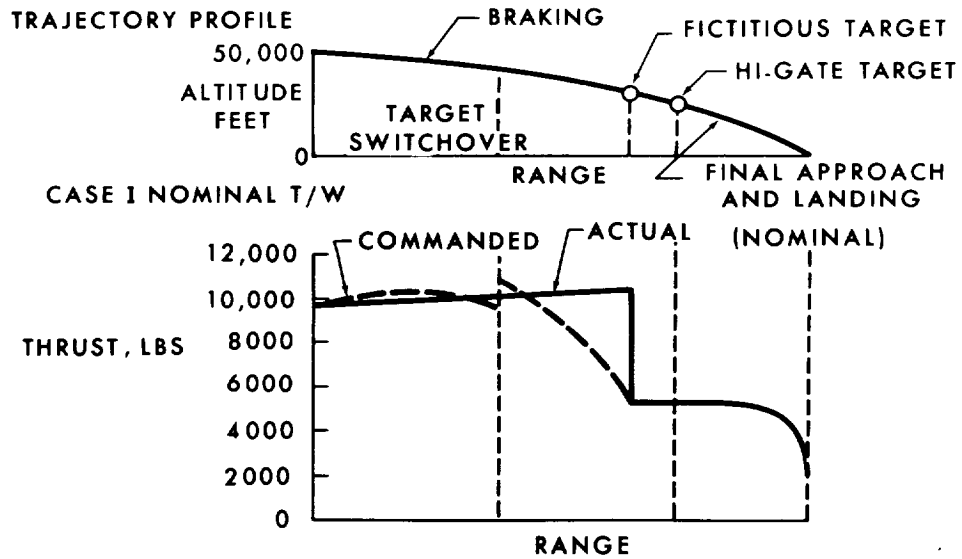

FIGURE 19

THRUST BEHAVIOR FOR LIMITED THROTTLE GUIDANCE

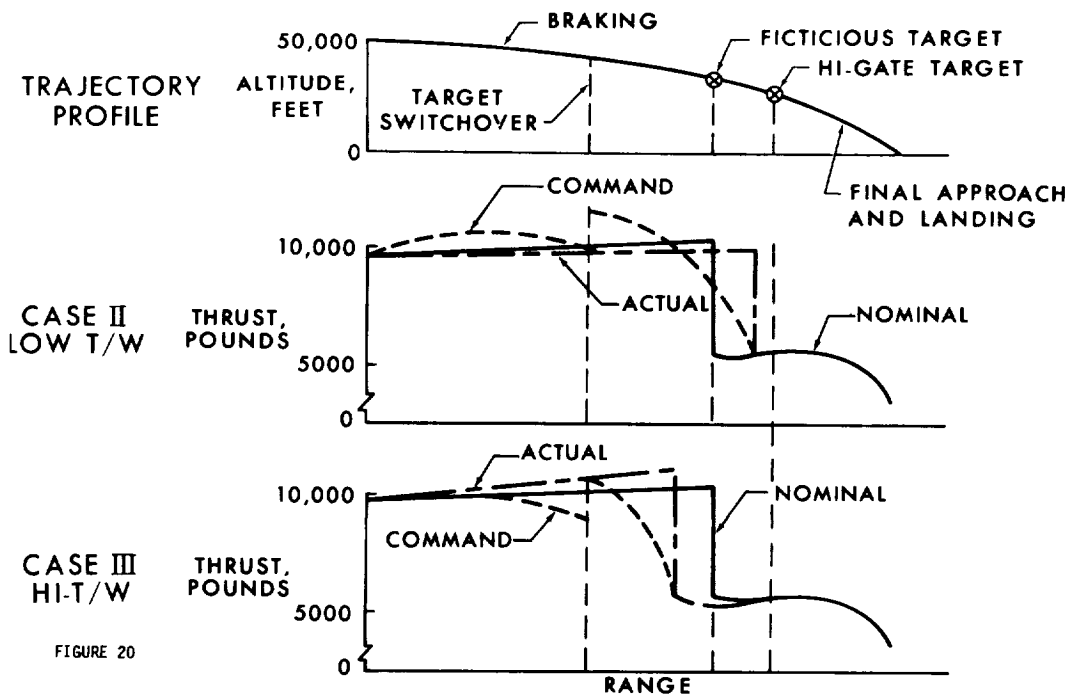

FIGURE 20

ΔV PENALTY DUE TO FIXED THRUST UNCERTAINTIES

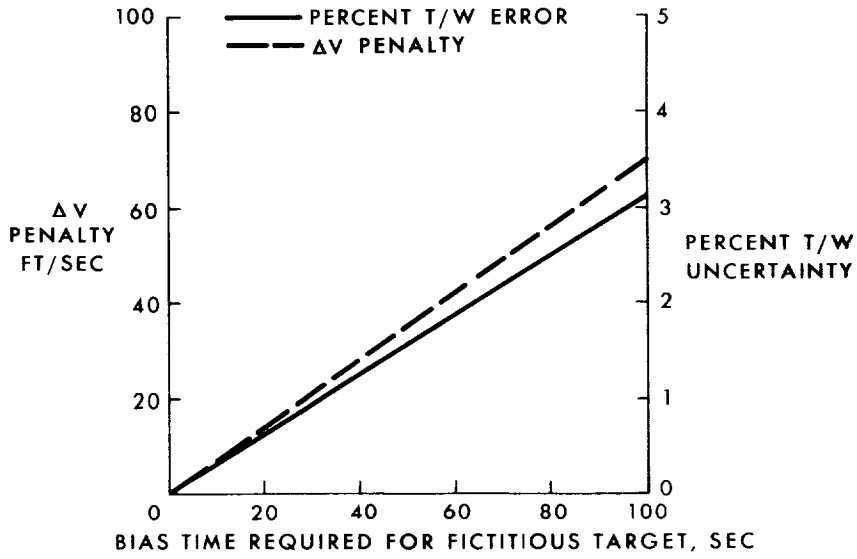

FIGURE 21

LANDING RADAR WEIGHTING FACTORS FOR ALTITUDE AND VELOCITY UPDATES

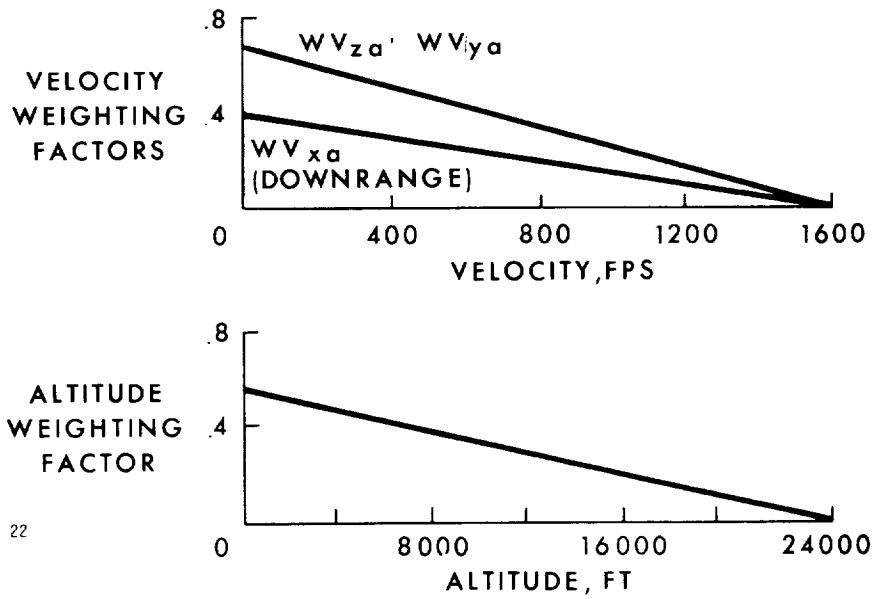
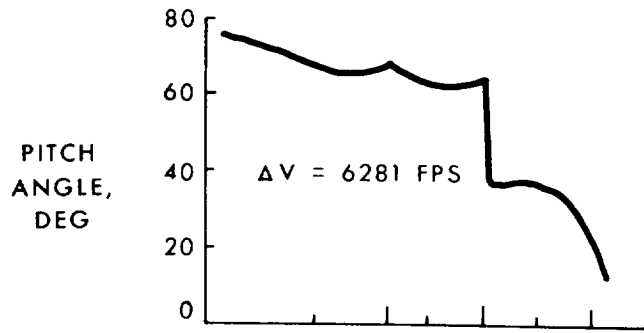

FIGURE 22

GUIDANCE COMMANDS FOR POWERED DESCENT

HI-GATE 6100 FT



IDEAL CONDITION —

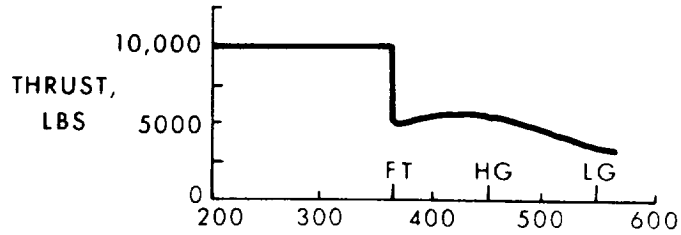

TIME FROM BRAKING INITIATION, SEC

FIGURE 23

NASA-S-66-6513 JUN

TERRAIN PROFILE DURING APPROACH TO LANDING SITE

0 20' N LAT 12 50' E LONG

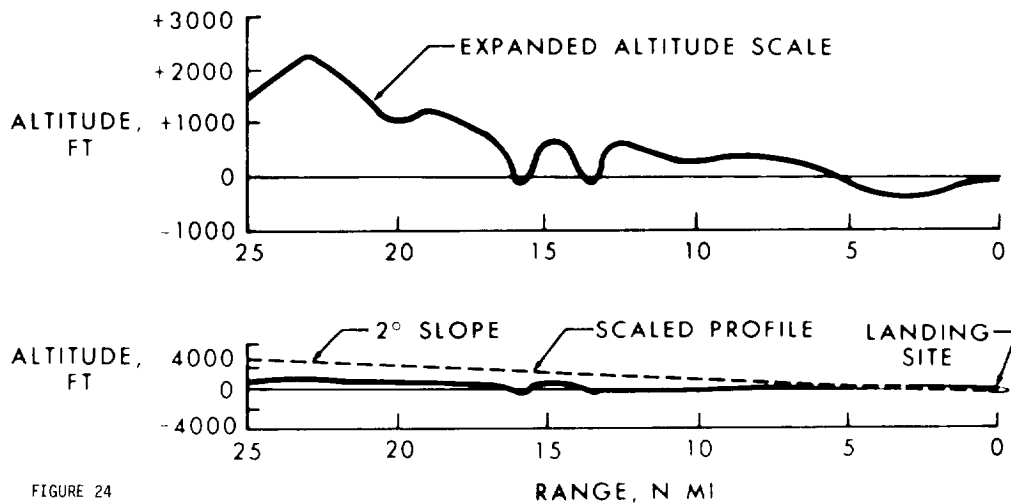

FIGURE 24

GUIDANCE COMMANDS FOR POWERED DESCENT

IDEAL CONDITION _____
TYPICAL ERROR
CONDITIONS
AND TERRAIN - - - - -

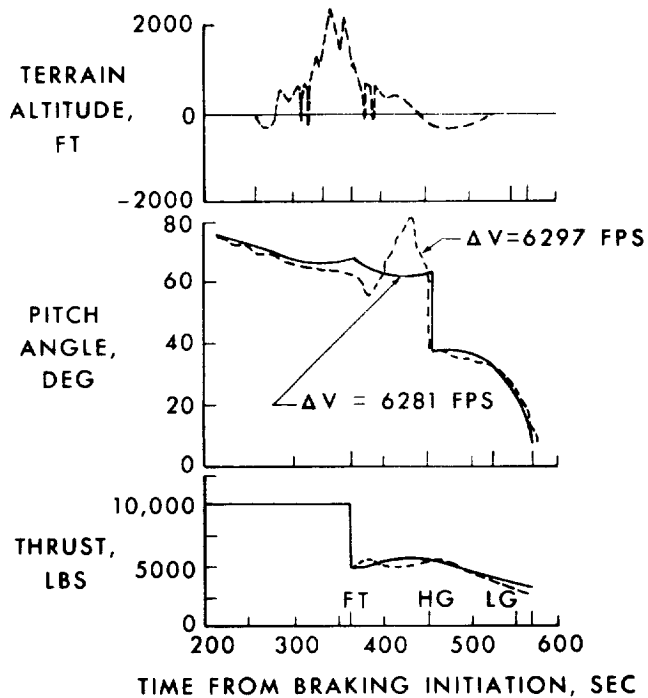

FIGURE 25

LM POWERED DESCENT GUIDANCE MONITORING

- PURPOSE OF MONITORING
 - PROVIDE ASSESSMENT OF TRAJECTORY
 - FAILURE DETECTION AND ISOLATION
 - ASSURE SAFE ABORT
- TWO TECHNIQUES
 - MONITORING TRAJECTORY BOUNDS OF PNGS AND AGS
 - PERIODIC DIFFERENCING OF PNGS AND AGS
- ALTITUDE - ALTITUDE RATE MOST SIGNIFICANT FOR ABORT SAFETY
- ALTITUDE RATE DEVIATIONS MOST SENSITIVE TO FAILURE DETECTION
- MSFN MEASUREMENT OF ALTITUDE RATE SHOULD BE SUFFICIENT FOR FAILED SYSTEM ISOLATION
- 3σ GUIDANCE DEVIATIONS WILL NOT ENDANGER FLIGHT PRIOR TO HI-GATE

FIGURE 26

PHASE II - FINAL APPROACH DESIGN

- OBJECTIVES
 - PROVIDE CREW VISIBILITY OF AND ADEQUATE TIME TO ASSESS LANDING AREA
 - PROVIDE CREW OPPORTUNITY TO ASSESS FLIGHT SAFETY
 - PROVIDE A RELATIVELY STABLE VIEWING PLATFORM
- CONSTRAINTS
 - FUEL LIMITATIONS
 - LM WINDOW SIZE
 - T/W OF DESCENT AND ASCENT ENGINE AND REQUIREMENT FOR SAFE STAGED ABORTS
 - TERRAIN LIGHTING/CONTRAST PROPERTIES
- VARIABLES
 - PITCH ATTITUDE
 - TRANSITION ALTITUDE
 - FLIGHT PATH ANGLE
 - LOOK ANGLE TO LANDING AREA REFERENCED TO THRUST AXIS

FIGURE 27

FACTORS AFFECTING CHOICE OF HI-GATE ALTITUDE

- RANGE FROM WHICH LANDING AREA CAN BE ASSESSED
- TIME REQUIRED TO ASSESS LANDING AREA
- FLIGHT SAFETY REQUIREMENTS WITH REGARDS TO TERRAIN ALTITUDE UNCERTAINTIES, LANDING RADAR OPERATING RELIABILITY, AND ASCENT ENGINE ABORT BOUNDARY

FIGURE 28

ABORT CAPABILITY BOUNDARIES

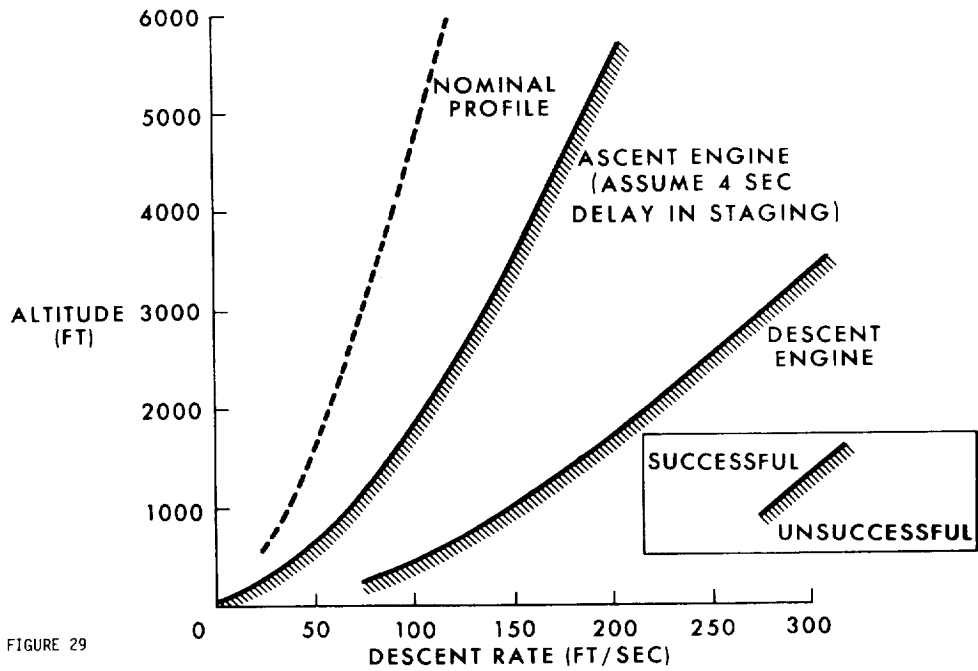

FIGURE 29

FACTORS CONTRIBUTING TO UNCERTAINTIES IN ALTITUDE ABOVE TERRAIN

- GUIDANCE AND NAVIGATION UNCERTAINTIES (1500 FT ALT 1σ)
- LUNAR RADIUS BIAS MAGNITUDE (3200 FT ALT)
- LUNAR RADIUS RANDOM MAGNITUDE (3200 FT ALT 1σ)
- PRESENT ABILITY TO DETERMINE MARIA AREA SLOPES ($\pm 3^\circ$ 3σ) (FUNCTION OF LANDING DISPERSIONS)
- ALLOWABLE TERRAIN VARIATIONS WITHIN $\pm 2^\circ$ SLOPE AND $\pm 5\%$ OF NOMINAL ALTITUDE (FUNCTION OF LANDING DISPERSIONS)

FIGURE 30

DETERMINATION OF MINIMUM HI-GATE ALTITUDE WITHOUT LR UPDATING

ORBIT NAVIGATION	3 σ ALTITUDE UNCERTAINTIES,* FT			ALTITUDE BIASES, FT			MINIMUM HI-GATE ALTITUDE FT
	PGNCS	TERRAIN PROFILE	LUNAR RADIUS	LUNAR RADIUS	TERRAIN PROFILE	STAGED ABORT	
MSFN	3700	4700	13,700	9800	4300	3500	32,600
MSFN & LANDING SITE UPDATE	3700	700	1700	—	700	1800	6700
PGNCS & LANDING SITE UPDATE	4500	1000	1700	—	800	1800	7500

* 3 σ UNCERTAINTIES ARE ROOT-SUM-SQUARED

FIGURE 31

ΔV PENALTY FOR HI-GATE ALTITUDE VARIATION-TYPICAL FLIGHT PATH ANGLE = 15°

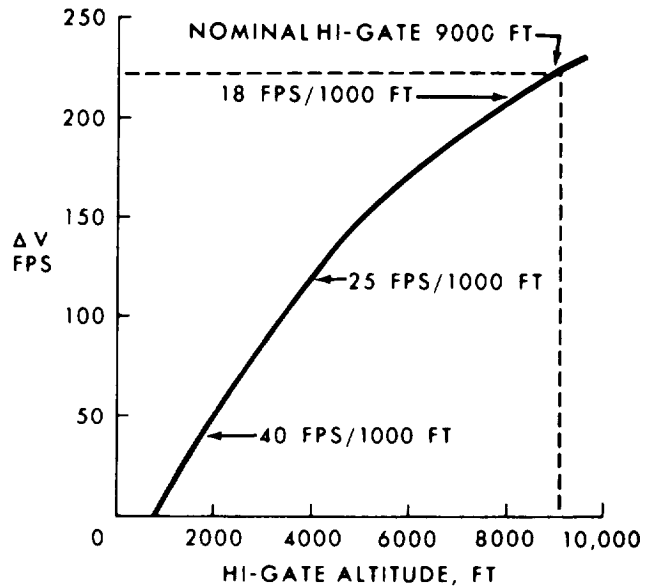

FIGURE 32

ΔV PENALTY FOR LOOK ANGLE AND FLIGHT PATH ANGLE (HI-GATE 9000FT)

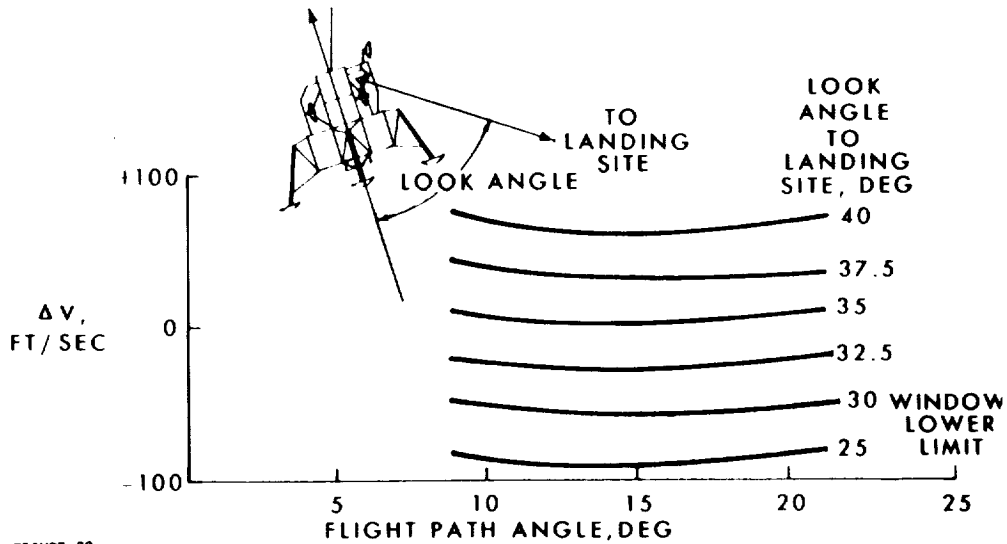

FIGURE 33

COMPARISON OF DESIGN TRAJECTORY AND FUEL OPTIMUM

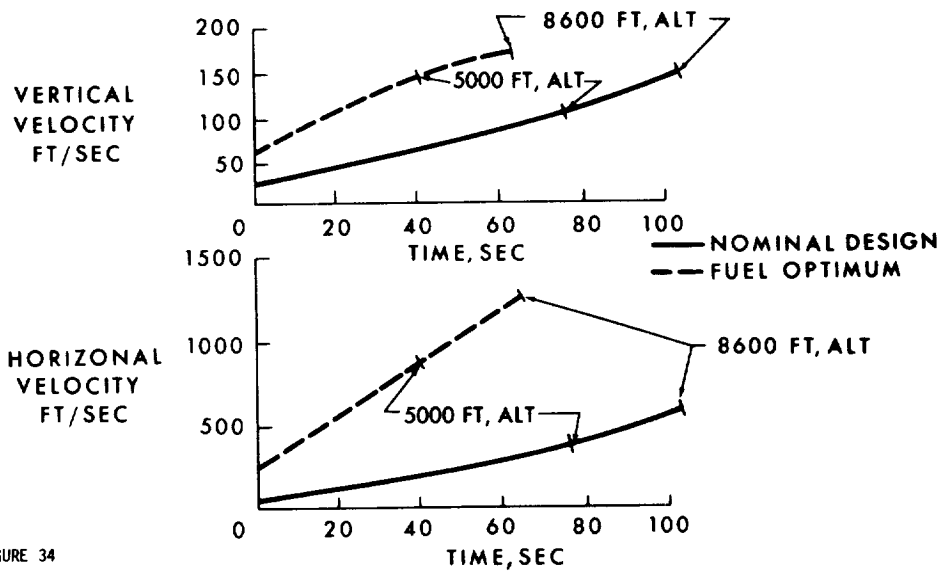

FIGURE 34

OVERHEAD PROFILE OF FOOTPRINT CAPABILITY FROM 8000 FT ALTITUDE

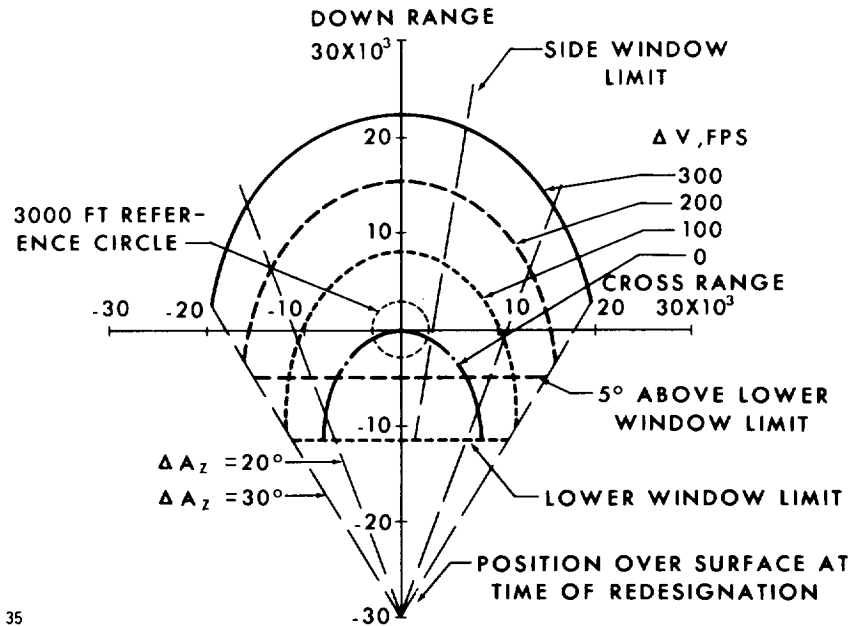

FIGURE 35

VARIATION OF FOOTPRINT CAPABILITY WITH ALTITUDE

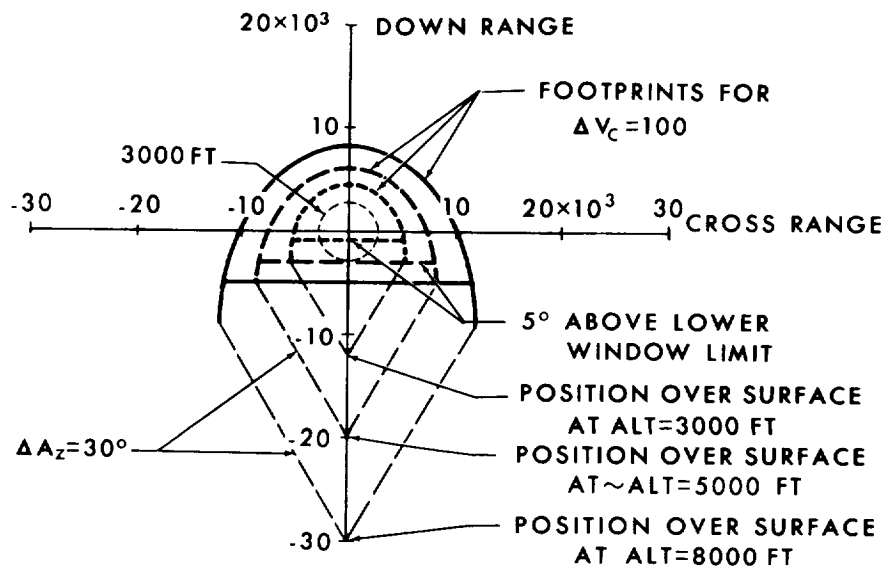

FIGURE 36

VARIATION OF FOOTPRINT WITH ALTITUDE DURING DESCENT

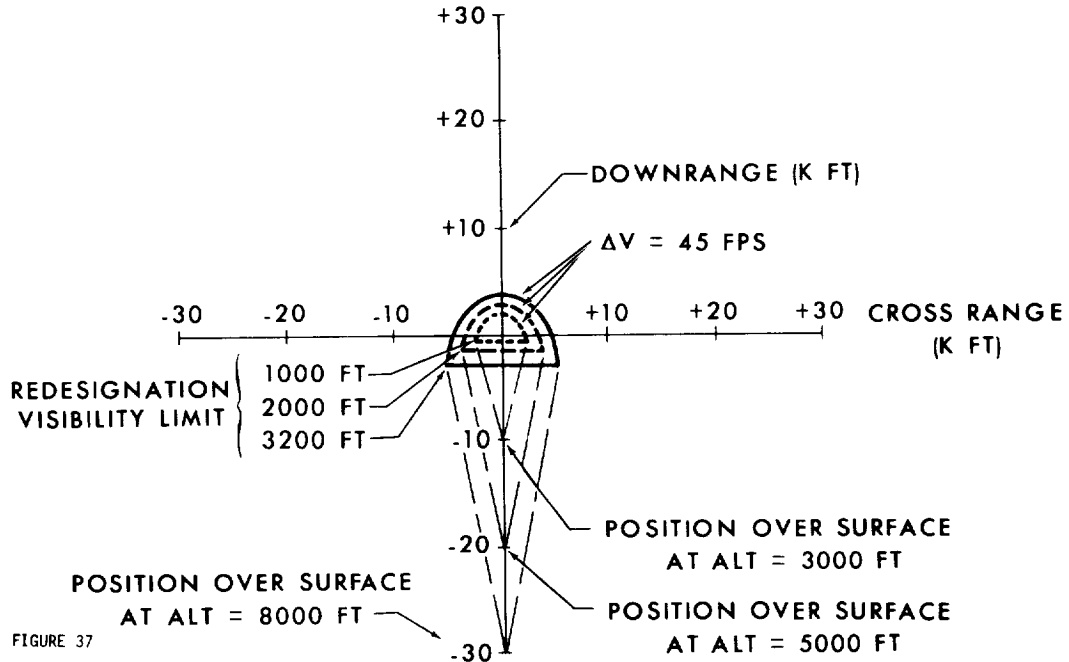

FIGURE 37

LANDING FOOTPRINT AS SEEN BY PILOT FROM 8000 FT ALTITUDE

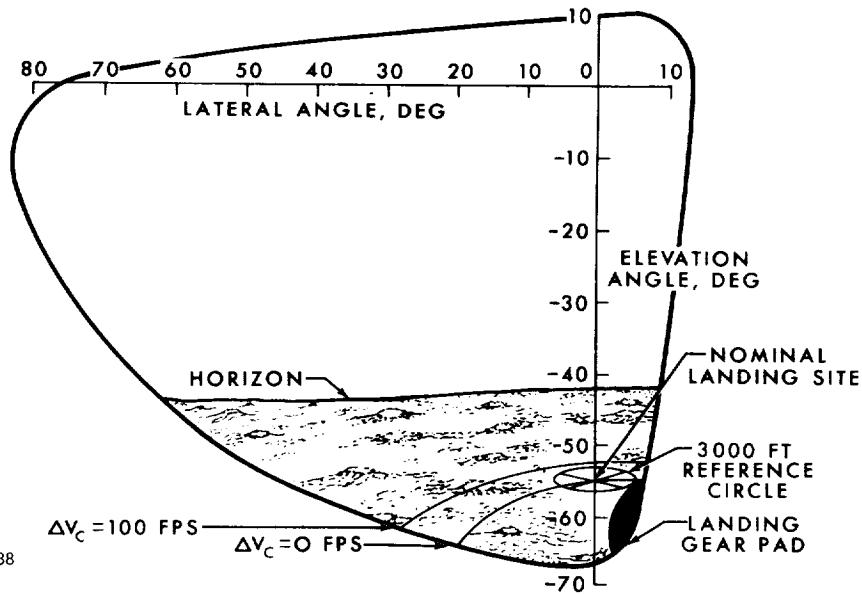

FIGURE 38

MARKING DETAILS OF LANDING POINT DESIGNATOR GRID

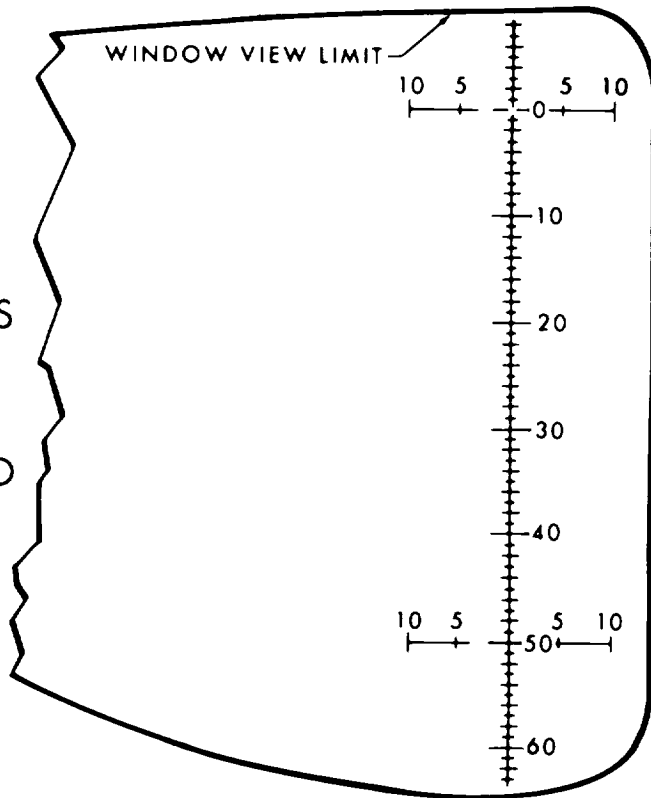

FIGURE 39

LANDING POINT DESIGNATION

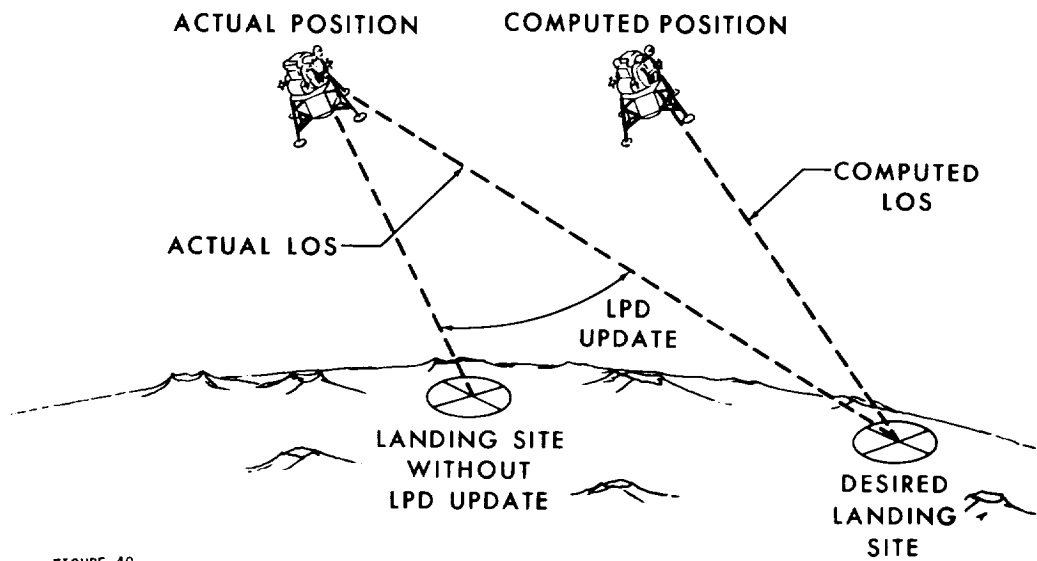

FIGURE 40

REDESIGNATION ERROR SOURCES

- TERRAIN
- GUIDANCE ALTITUDE DISPERSIONS (NON UPDATED)
- BORE SIGHT INSTALLATION
- IMU ALINEMENT
- APPLICATION ERRORS

FIGURE 41

NASA-S-66-6626 JUL 6

LANDING POINT DESIGNATOR ERROR SOURCES FLIGHT PATH ANGLE = 14°

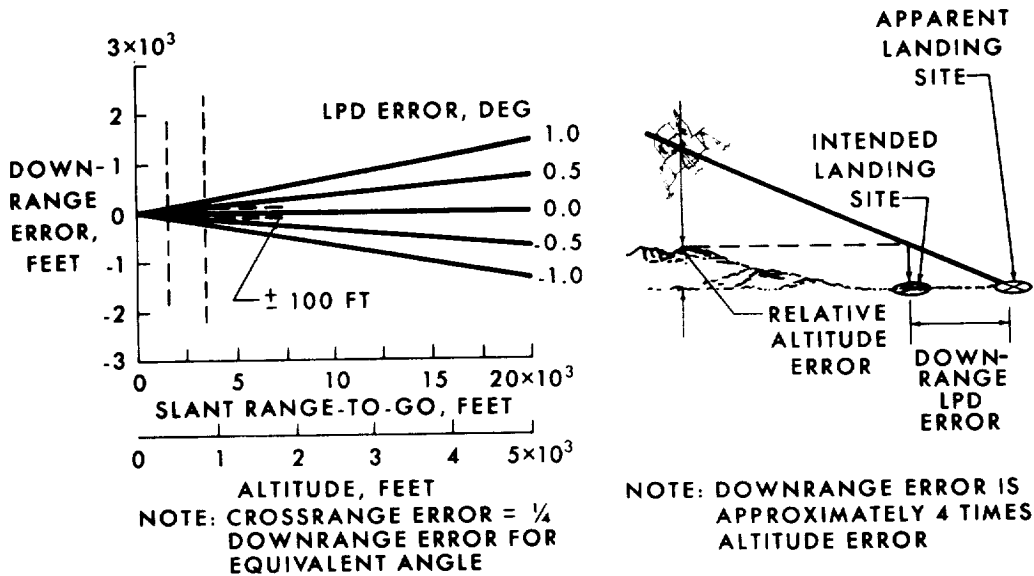

FIGURE 42

TIME HISTORIES OF LINE OF SIGHT TO LANDING POINT FOR ALTERNATE SITE SELECTIONS AT 5000 FT ALTITUDE

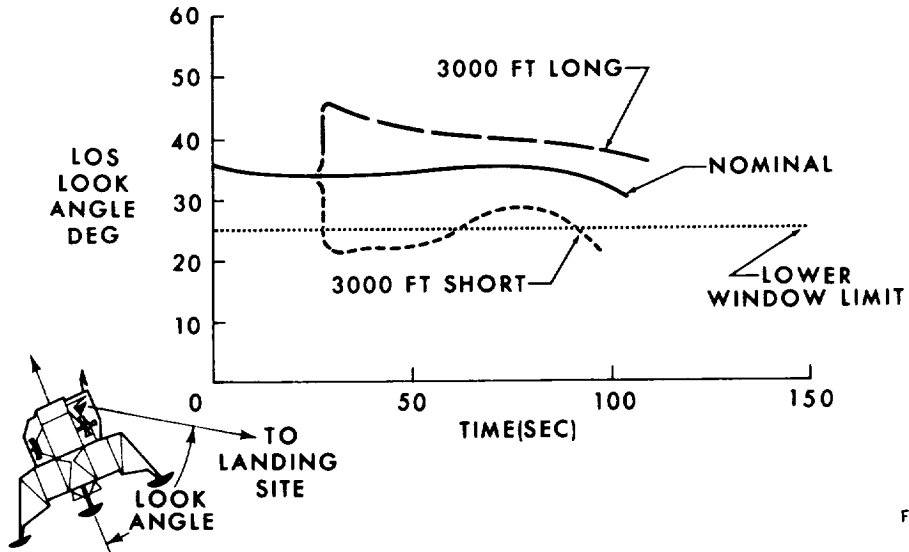

FIGURE 43

LM CREW ATTITUDE RELATIVE TO LUNAR SURFACE

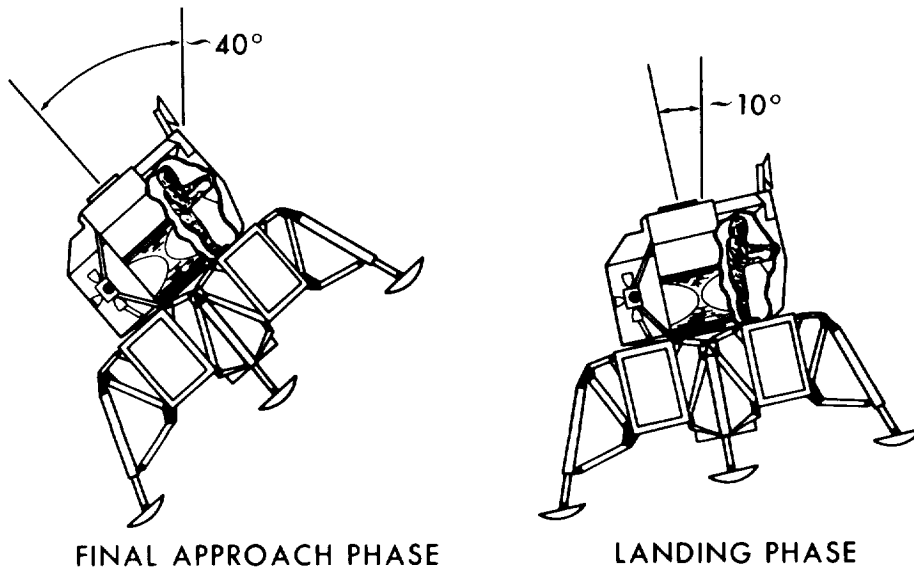

FIGURE 44

LANDING PHASE DESIGN

- OBJECTIVES

- ALLOW DETAIL ASSESSMENT AND FINAL SELECTION OF LANDING POINT
- ALLOW SOME MANEUVERING CAPABILITY AND FOOT-PRINT FOR LANDING POINT ADJUSTMENT

- CONSTRAINTS

- FUEL UTILIZATION
- WINDOW AND LIGHTING VISIBILITY
- TERRAIN AND POSSIBLE DUST
- LIMITED ATTITUDE FOR MANEUVERING
- STAGED ABORT BOUNDARIES

FIGURE 45

PILOT VIEW DURING LANDING PHASE

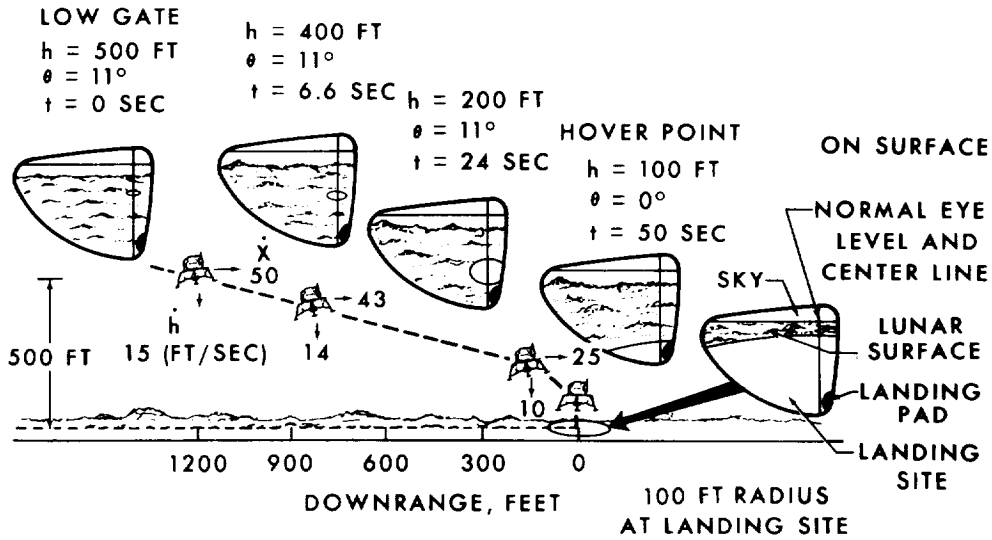

FIGURE 46

TRAJECTORY CHARACTERISTICS FOR LANDING PHASE

FLIGHT PATH ANGLE = 17°
 THRUST ACCELERATION = 5.46 FT/SEC²
 PITCH ANGLE, θ , = 11°

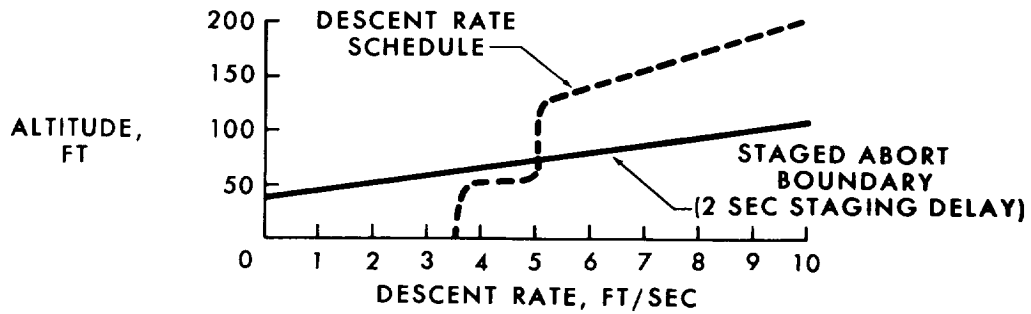

FIGURE 47

LANDING PHASE FUEL BUDGET BASELINE TRAJECTORY ALLOWANCE 390 FPS

● CONTINGENCY ALLOWANCE, FPS	MEAN	RANDOM (3 σ)
● MANUAL CONTROL TECHNIQUE VARIATIONS	80	100
● EFFECT OF LANDING RADAR UNCERTAINTIES	80	65
● LANDING SITE INSPECTION	80	-
● FUEL DEPLETION MARGIN	40	-
TOTAL	280	119 (RSS)

FIGURE 48

SUMMARY OF LM DESCENT BUDGET BASELINE TRAJECTORY ALLOWANCES

<u>PHASE</u>	<u>ΔV, FPS</u>		
DESCENT TRANSFER	97		
POWERED DESCENT: BRAKING	5135		
FINAL APPROACH	932		
LANDING	390		
SUBTOTAL	6554		
CONTINGENCY ALLOWANCES			
	<u>MEAN</u>	<u>3σ</u>	
DESCENT TRANSFER - INCREASE CSM ALTITUDE 10 N MI	13		
BRAKING: INCREASE CSM ALTITUDE 10 N MI	15		
THRUST DISPERSIONS OF + 2%		48	
NAVIGATION ALT DISPERSIONS (3000 FT 3σ)		60	
FINAL APPROACH - LANDING SITE UPDATE	45	15	
LANDING: MANUAL CONTROL VARIATIONS	80	100	
EFFECT OF LR UNCERTAINTIES	80	65	
LANDING SITE INSPECTION	80		
FUEL DELETION MARGIN	40		
SUBTOTAL	353	143 (RSS)	
TOTAL BUDGET	7050		

FIGURE 49

TIME HISTORY OF LM DESCENT FUEL EXPENDITURE

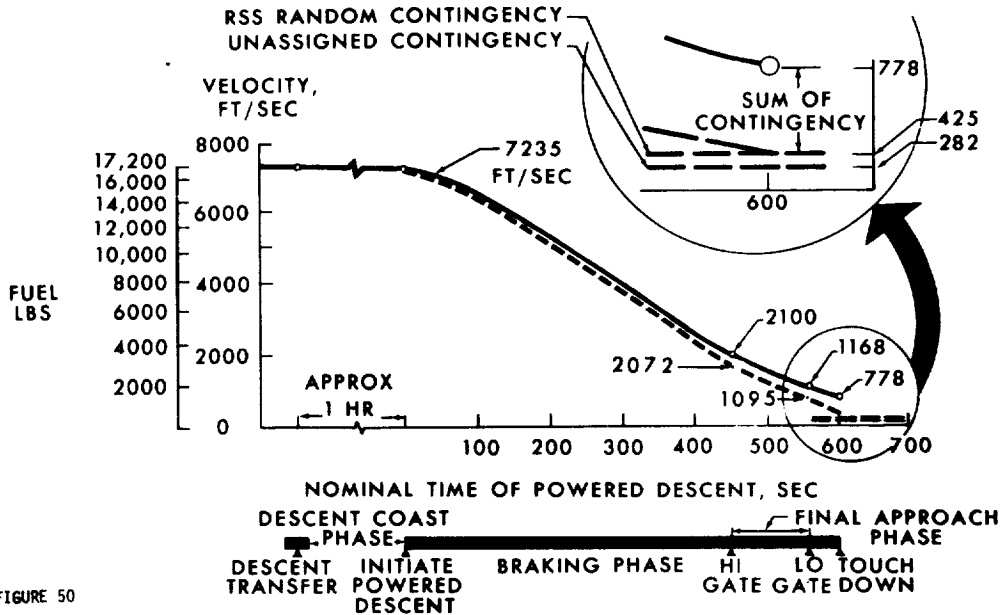

FIGURE 50

LM LANDING TOUCHDOWN CONTROL

MODES

- AUTOMATIC
- MANUAL-AIDED BY AUTOMATIC CONTROL LOOPS
 - VISUAL
 - IFR (BECAUSE OF DUST OR LIGHTING)

MAJOR SOURCES OF SYSTEM ERRORS

- LANDING RADAR VELOCITY MEASUREMENT
- IMU MISALIGNMENT
- DISPLAY SYSTEM AND PILOT (MANUAL ONLY)
- CG POSITION

CONSTRAINTS

- LANDING GEAR DESIGN LIMITS
- DESCENT ENGINE REQUIRED TO BE OFF BY TOUCHDOWN

FIGURE 51

DESCENT ENGINE SHUTDOWN SEQUENCE

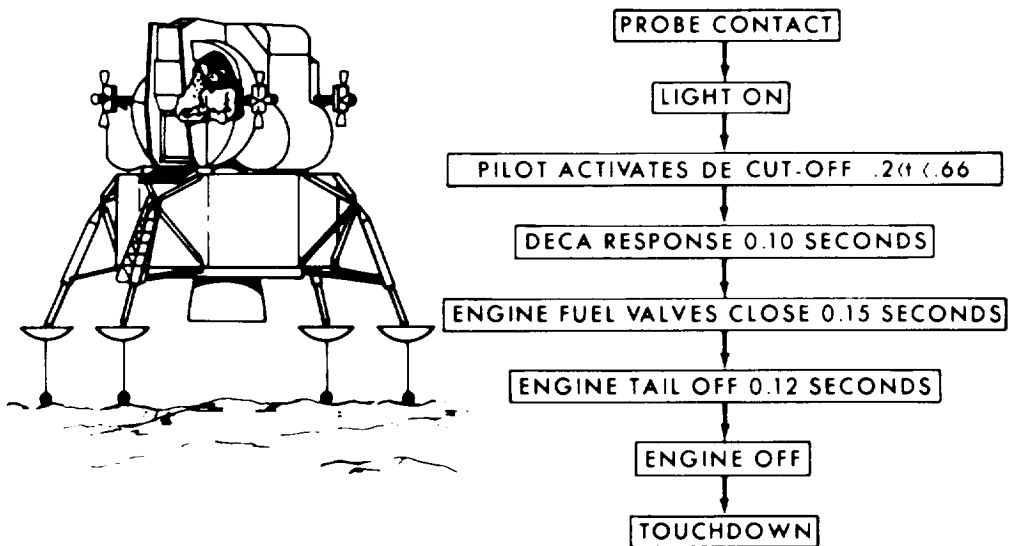

FIGURE 52

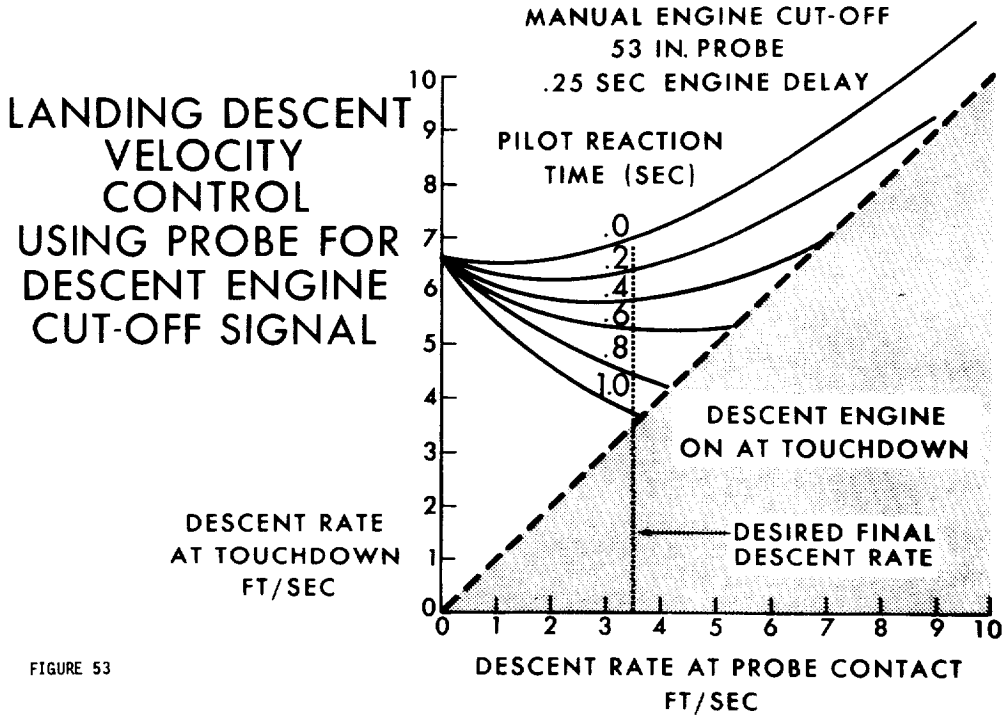

FIGURE 53

LM DESCENT ENGINE CUT-OFF PILOT REACTION TIME

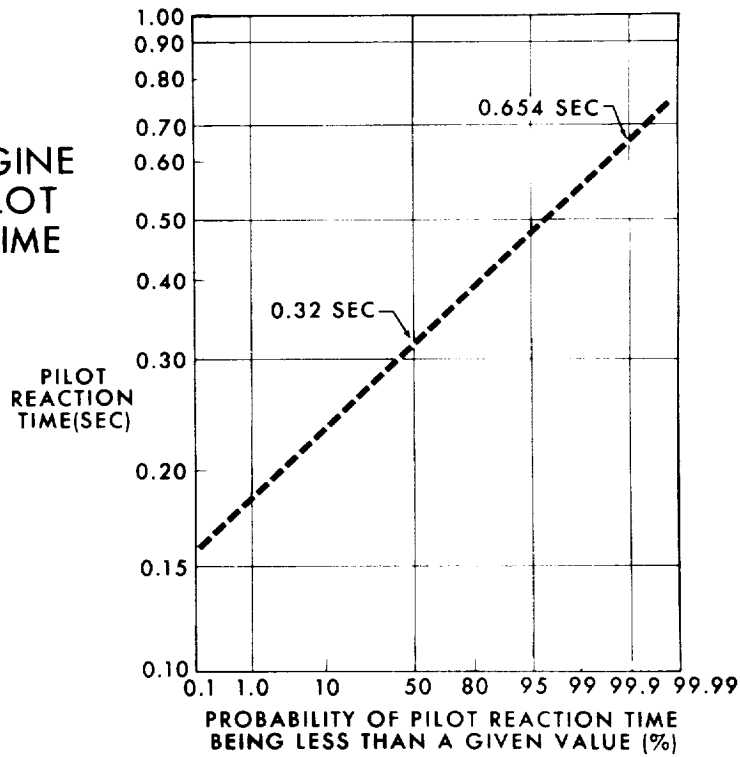

FIGURE 54

ASSUMED LANDING RADAR ERROR MODEL FOR LANDING CONTROL ANALYSIS

	SPECIFICATION	PREDICTED	DEGRADED
VERTICAL	1.5 FT/SEC	.75 FT/SEC	1.5 FT/SEC
LATERAL	1.5 FT/SEC	1.5 FT/SEC	3.0 FT/SEC
FORWARD	1.5 FT/SEC	1.5 FT/SEC	3.0 FT/SEC

FIGURE 55

NASA-S-65-9331

MANUAL
CONTROL
OF
LANDING
VELOCITIES
WITH
SYSTEM
ERRORS

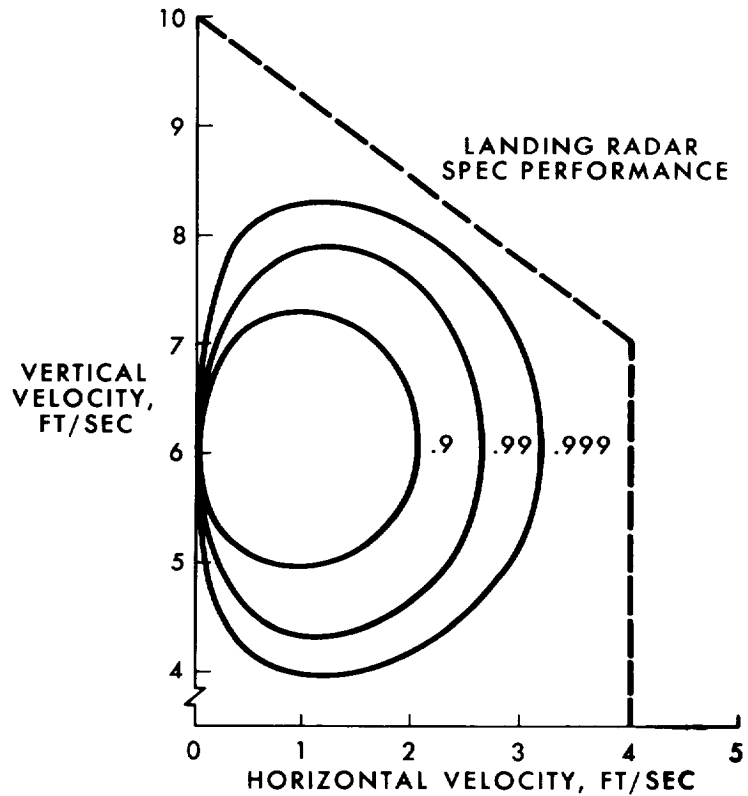

FIGURE 56

EFFECT OF
LANDING RADAR
ERRORS ON
VELOCITIES IN
MANUAL
CONTROL OF
LANDING

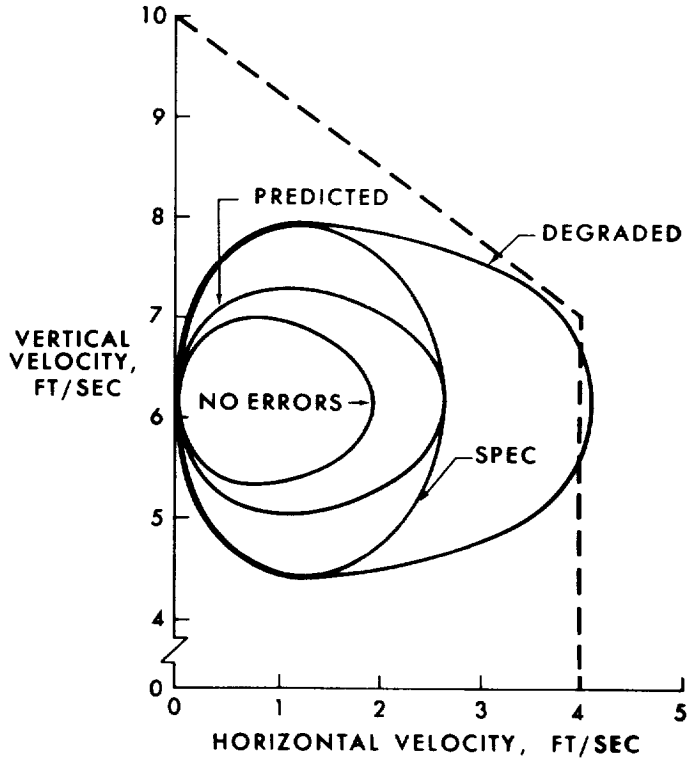

FIGURE 57

COMPARISON
OF AUTOMATIC
AND MANUAL
CONTROL OF
VELOCITIES
LANDING

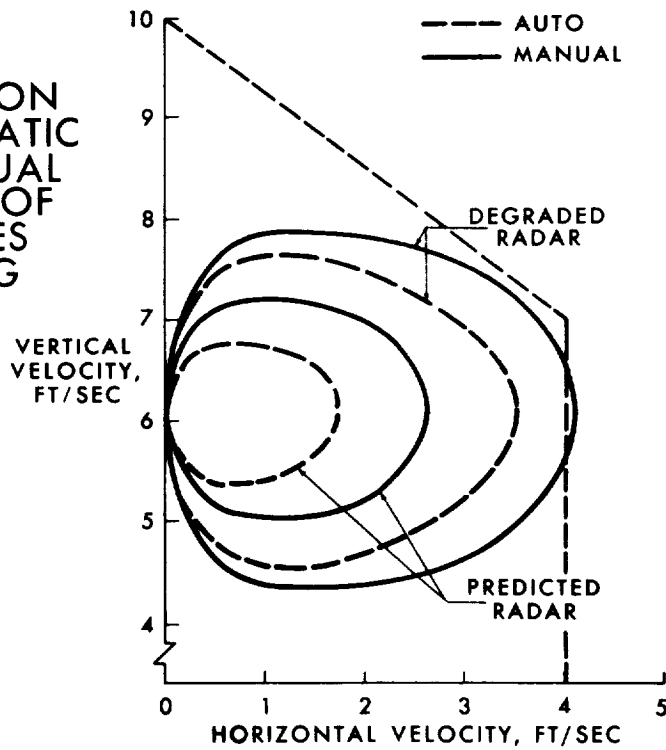

FIGURE 58

