

Lecture 14
Miscellaneous topics
in remediation:
New remediation technologies;
technical impracticability; and
gasoline additives

New remediation technologies

Phytoremediation

Electro-kinetic remediation

Bedrock fracturing

Circulating wells/in-well treatment

In-situ oxidation

Dual-phase vapor extraction

Phytoremediation

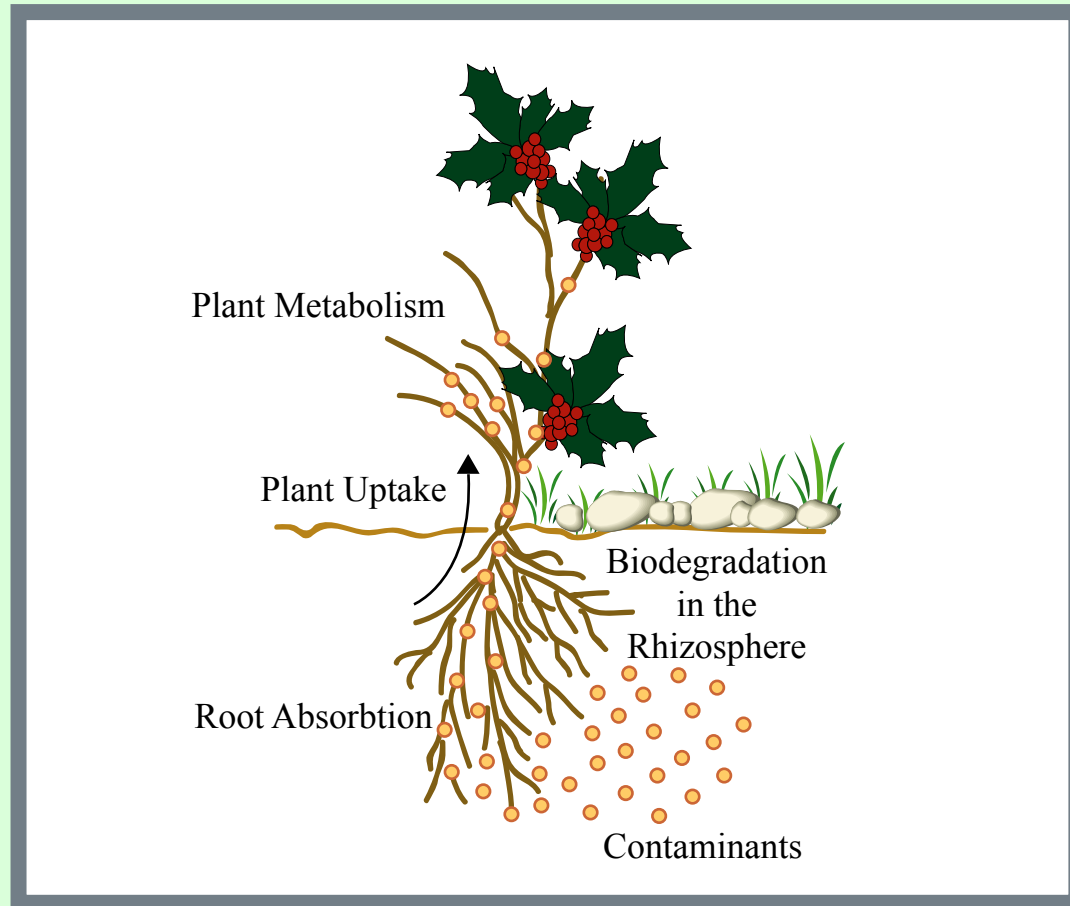

Phytoremediation

Phytotransformation – uptake from soil and ground water, transformation within the plant

Rhizosphere bioremediation – augmentation of bacterial processes in plant root zone

Phytostabilization – hydraulic control by pumping action of trees, physical soil stabilization by roots

Phytoextraction – use of metal-accumulating plants to extract metals from soils and concentrate them in roots, stems, or leaves

Rhizofiltration – plant roots acting to sorb, concentrate, or precipitate metals

Explosives rhizosphere bioremediation

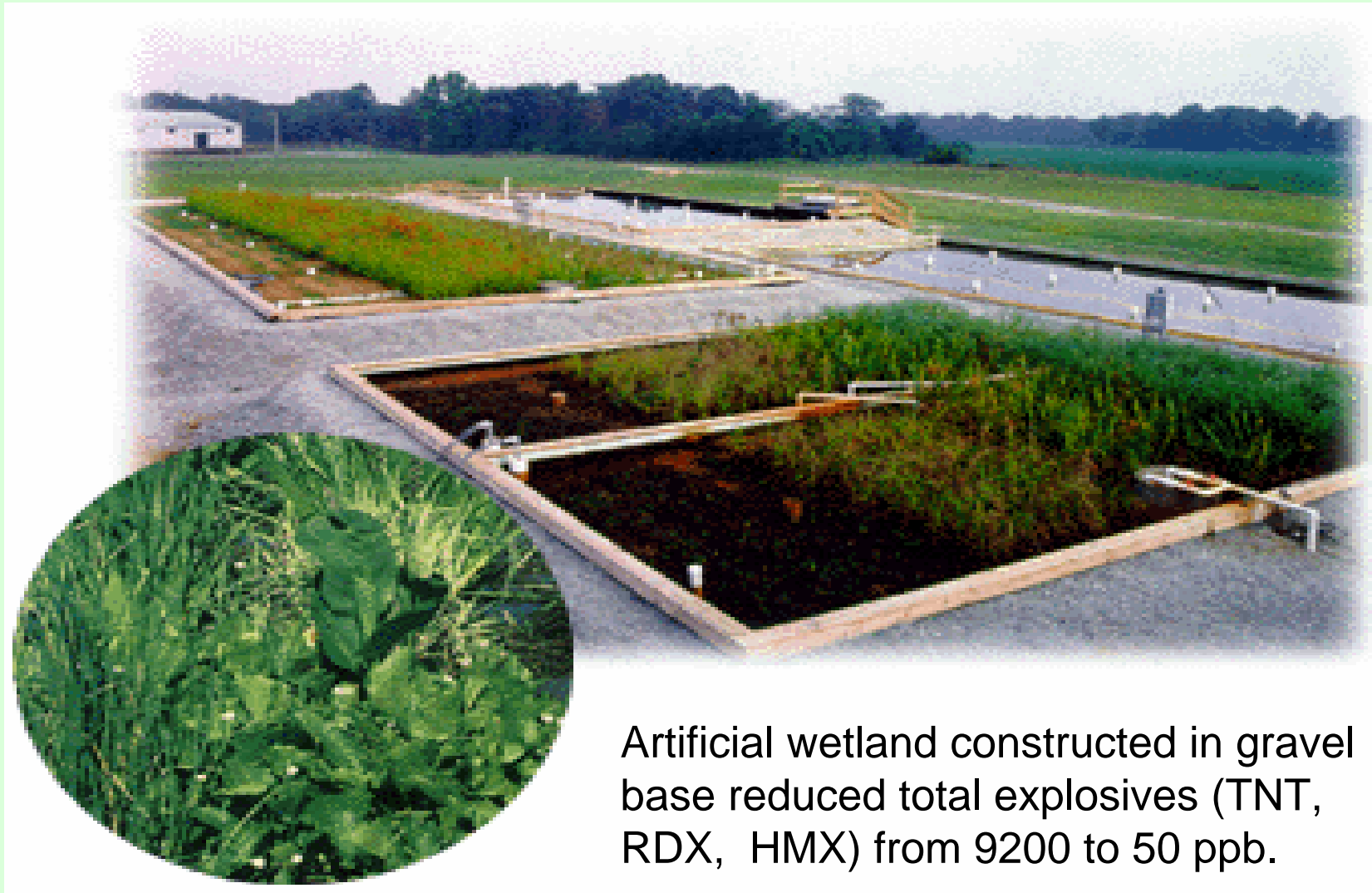

Artificial wetland constructed in gravel base reduced total explosives (TNT, RDX, HMX) from 9200 to 50 ppb.

Poplar trees for phytoextraction



Courtesy of Melanie Pincus. Used with permission.

Source: Pincus, M., 2003. Greener Cleaners, Using Phytoremediation to Remediate Environmental Toxins. Student paper for MIT Course 1.34.

Wild mustard plant for metals phytoextraction



Wild mustard plant will hyperaccumulate nickel, reaching shoot concentrations as high as 1.2%.

Persans, M. W., K. Nieman, and D. E. Salt, 2001. Functional activity and role of cation-efflux family members in Ni hyperaccumulation in *Thlaspi goesingense*. PNAS. Vol. 98, No. 17, Pg. 9995-10000. August 14, 2001.

Courtesy of David Salt. Used with permission.

Source: Salt, David E., undated. Molecular Physiology of Heavy Metal Accumulation and Tolerance in Plants. Horticulture and Landscape Architecture, Purdue University, West Lafayette, Indiana. <http://www.hort.purdue.edu/hort/people/faculty/salt.shtml>. Accessed March 28, 2004.

Persans, M. W., K. Nieman, and D. E. Salt, 2001. Functional activity and role of cation-efflux family members in Ni hyperaccumulation in *Thlaspi goesingense*. PNAS. Vol. 98, No. 17, Pg. 9995-10000. August 14, 2001.

The ability of *Thlaspi goesingense* to hyperaccumulate Ni seems to be governed in part by enhanced accumulation of Ni within leaf vacuoles. We have characterized genes from *T. goesingense* encoding putative vacuolar metal ion transport proteins, termed metal tolerance proteins (TgMTPs). These proteins contain all of the features of cation-efflux family members, and evidence indicates they are derived from a single genomic sequence (TgMTP1) that gives rise to an unspliced (TgMTP1t1) and a spliced (TgMTP1t2) transcript. Heterologous expression of these transcripts in yeast lacking the TgMTP1 orthologues COT1 and ZRC1 complements the metal sensitivity of these yeast strains, suggesting that TgMTP1s are able to transport metal ions into the yeast vacuole in a manner similar to COT1 and ZRC1. The unspliced and spliced TgMTP1 variants differ within a histidine-rich putative metal-binding domain, and these sequence differences are reflected as alterations in the metal specificities of these metal ion transporters. When expressed in yeast, TgMTP1t1 confers the highest level of tolerance to Cd, Co, and Zn, whereas TgMTP1t2 confers the highest tolerance to Ni. TgMTP1 transcripts are highly expressed in *T. goesingense* compared with orthologues in the nonaccumulators *Arabidopsis thaliana*, *Thlaspi arvense*, and *Brassica juncea*. We propose that the high-level expression of TgMTP1 in *T. goesingense* accounts for the enhanced ability of this hyperaccumulator to accumulate metal ions within shoot vacuoles.

Electrokinetic remediation

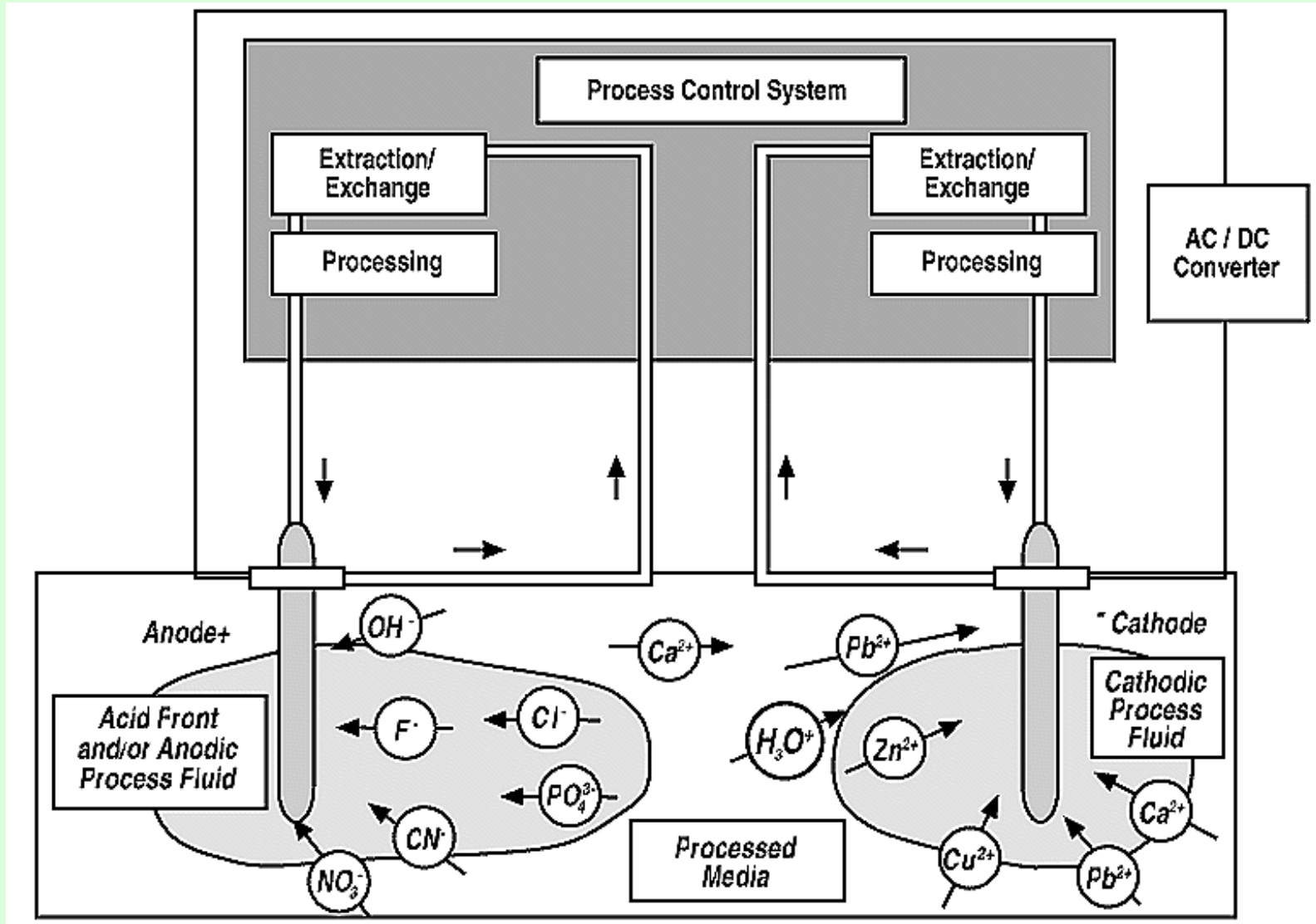

Lasagna process

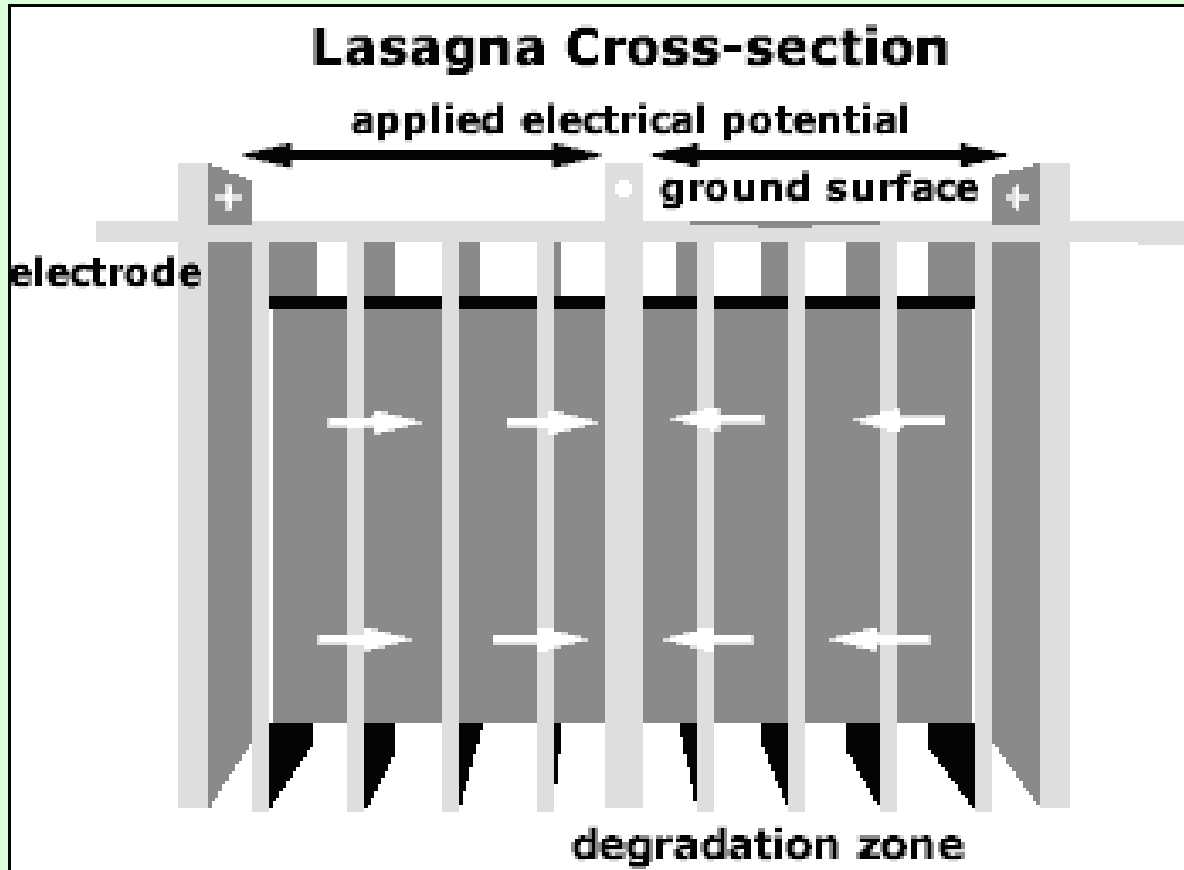

Electro-osmosis moves contaminant in low permeability environments

The Lasagna™ process works by using buried electrodes to move water through the soil. Applied current drives the water an inch a day from a positive to a negative electrode. The water picks up contaminants and moves them through treatment zones where they are trapped or degraded.

Thermal treatment (enhanced SVE)

See image in Bader, C. D., 1997. In-Situ Soil Remediation. *Remediation Management*. Vol. 3, No. 2, Pg. 22. Second Quarter 1997.

Thermal treatment of PCBs in soil

See image in Bader, C. D., 1997. In-Situ Soil Remediation. *Remediation Management*. Vol. 3, No. 2, Pg. 22. Second Quarter 1997.

After thermal treatment

See image in Bader, C. D., 1997. In-Situ Soil Remediation. *Remediation Management*. Vol. 3, No. 2, Pg. 22. Second Quarter 1997.

Fracturing of low-conductivity geologic media

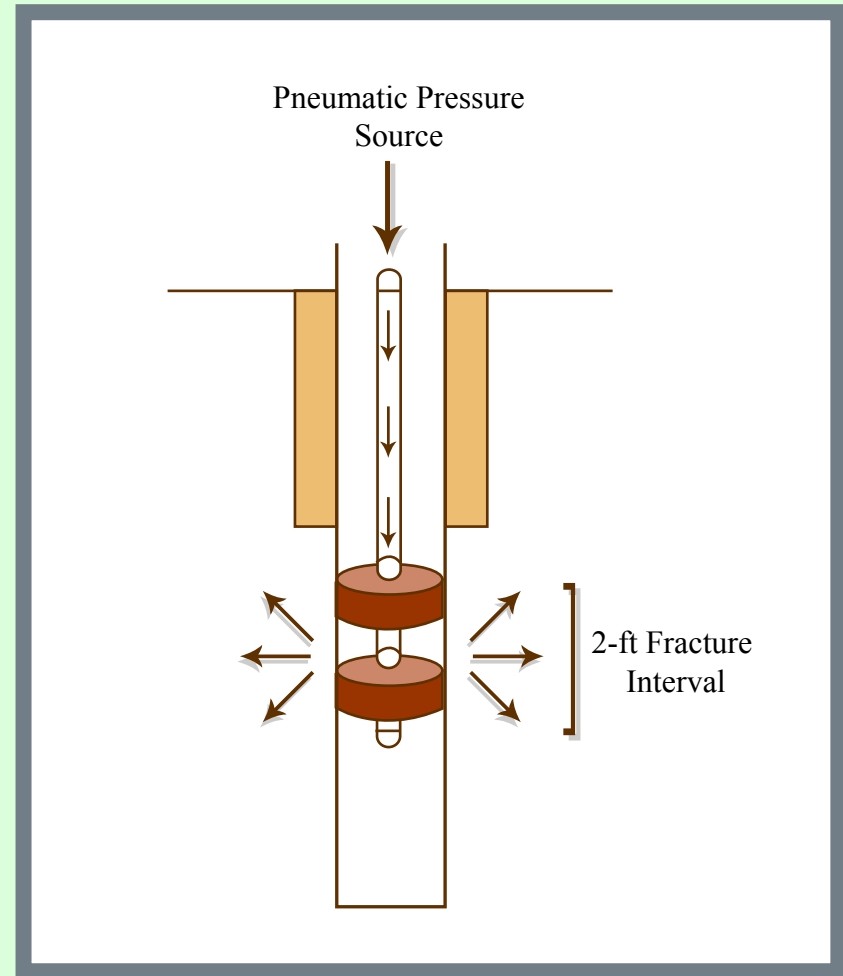

Circulating wells

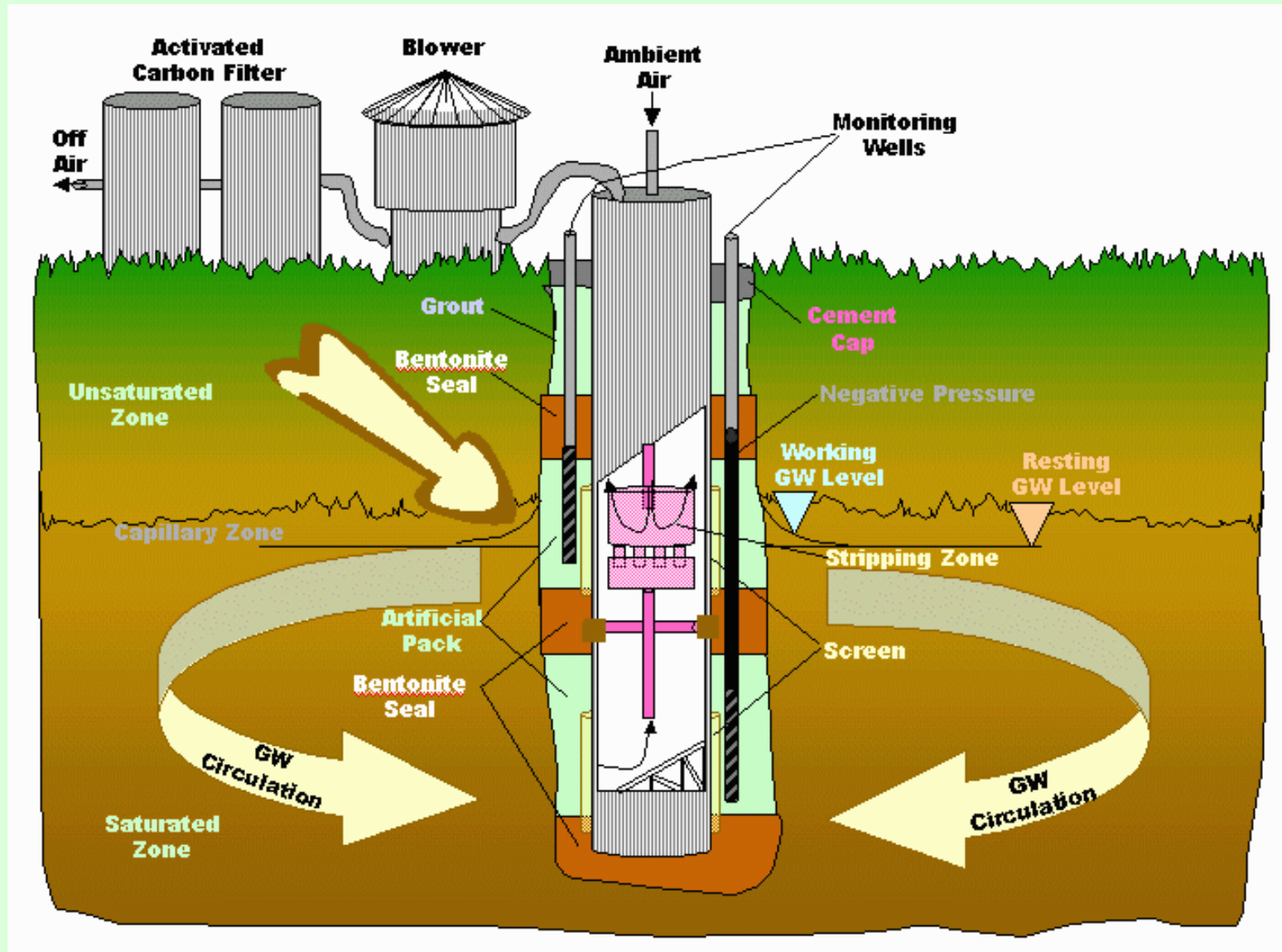

In-well air stripping

Vapors are extracted for ex-situ vapor treatment

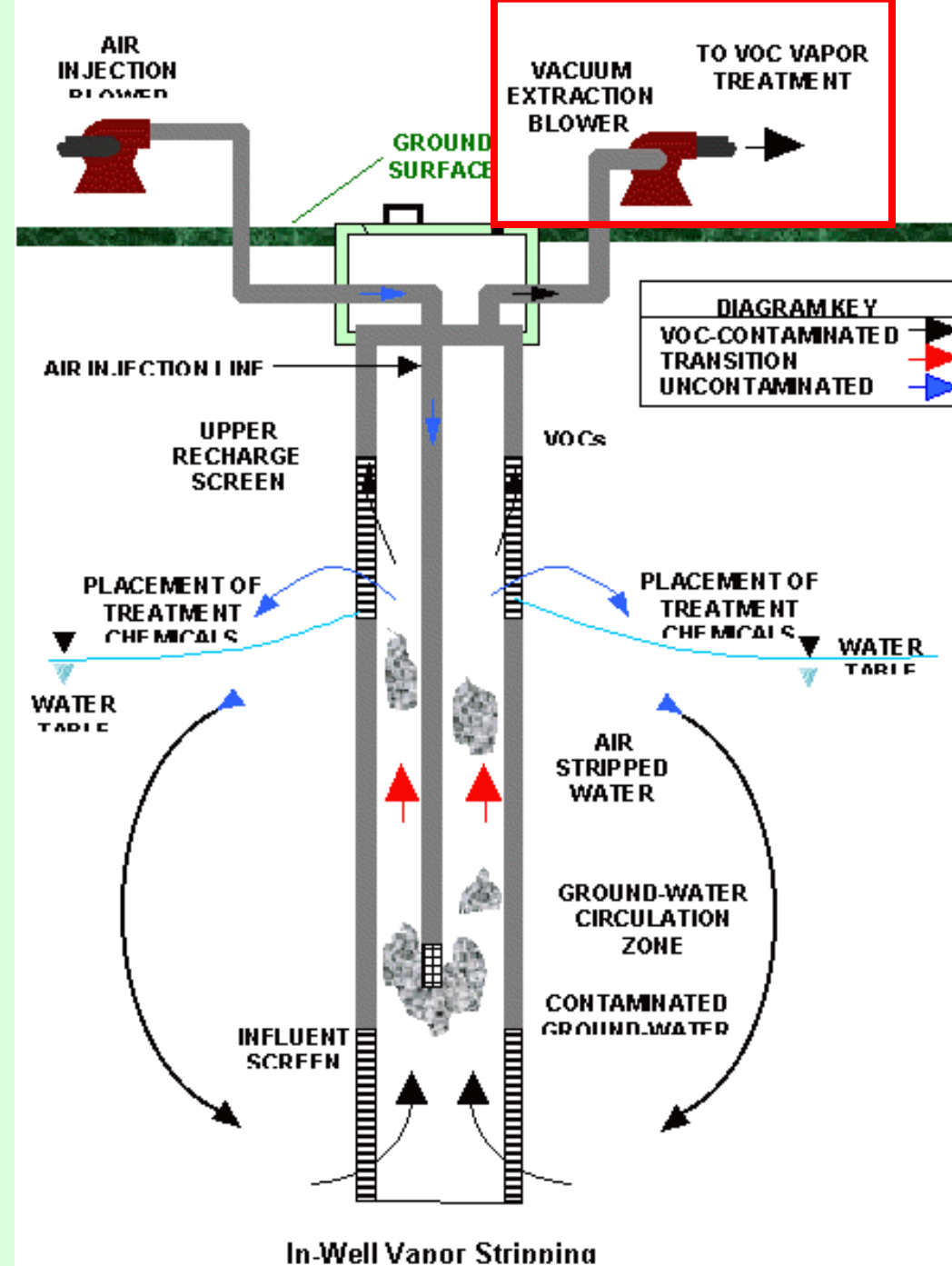

Density-driven convection

Vapors are discharged to vadose zone for in-situ degradation

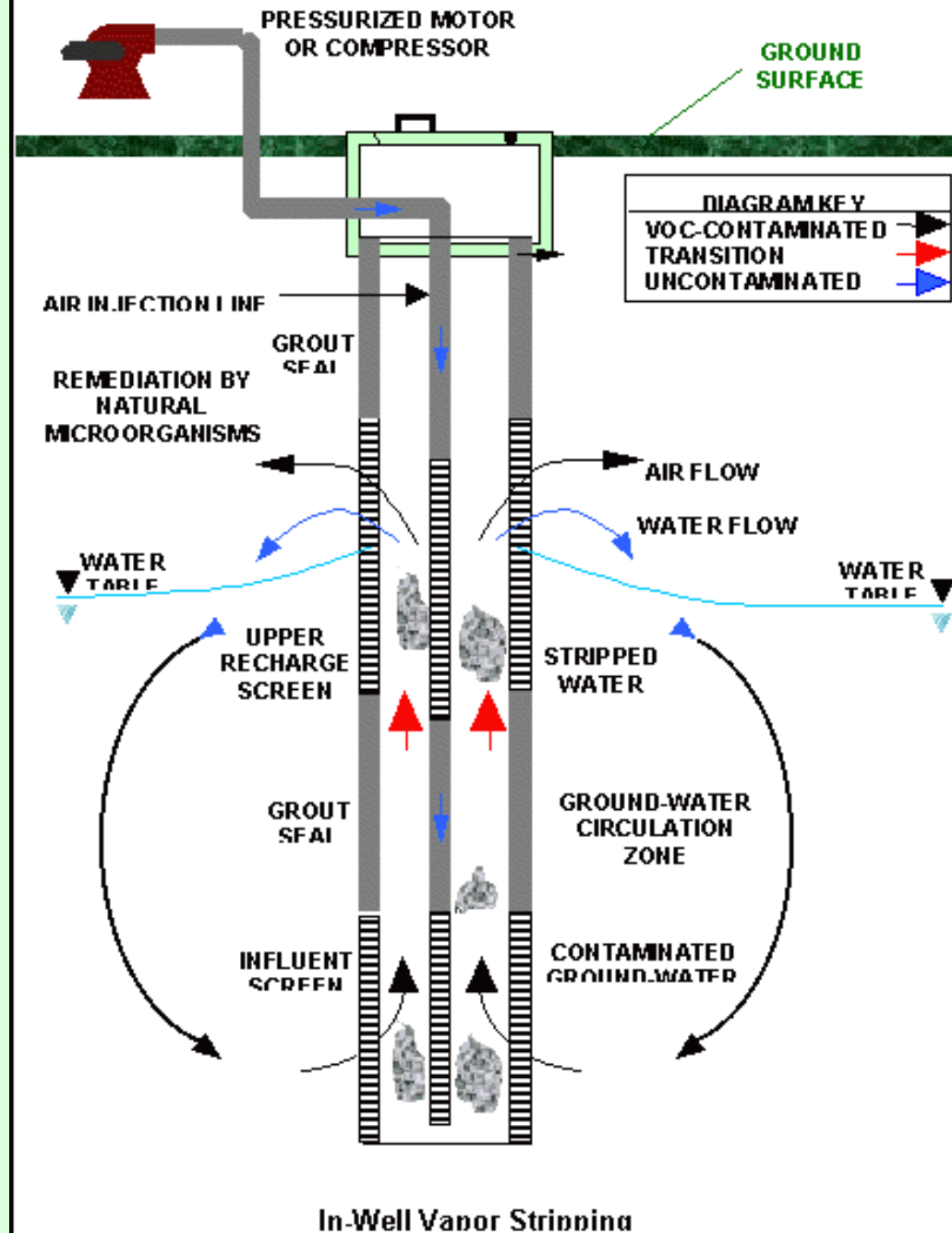

Dual-phase vapor extraction

2.1.1 STATIC

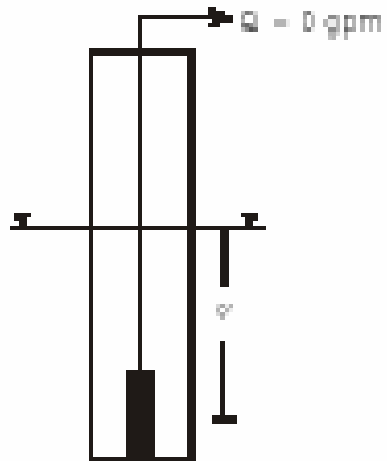

DRAWDOWN = 0

2.1.2 FLUID PUMPING ONLY

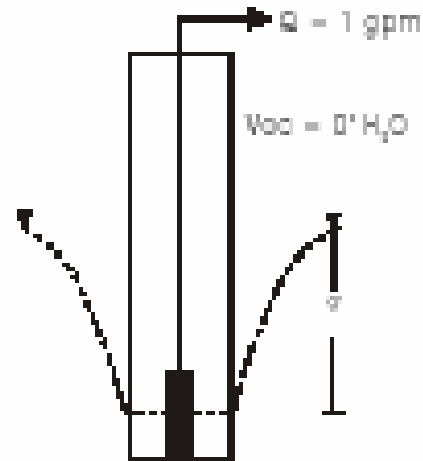

DRAWDOWN = s'

2.1.3 ONLY VACUUM

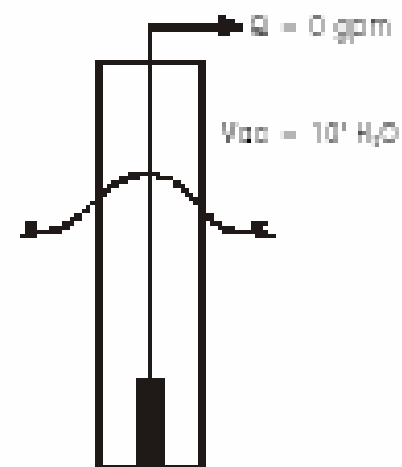

2.1.4 PUMPING AND VACUUM

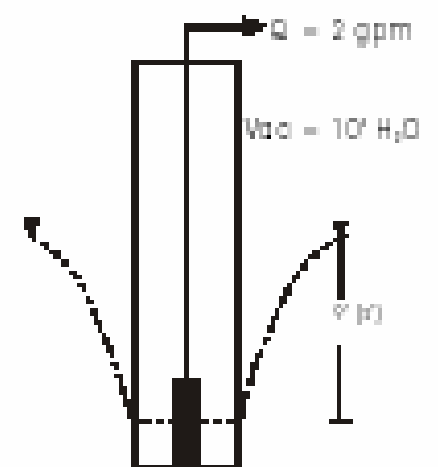

$$\begin{aligned} \text{EFFECTIVE } s' &= Vac + s' \\ &= 10' + s' \\ &= 19' \end{aligned}$$

Dual-phase extraction (DPE) well

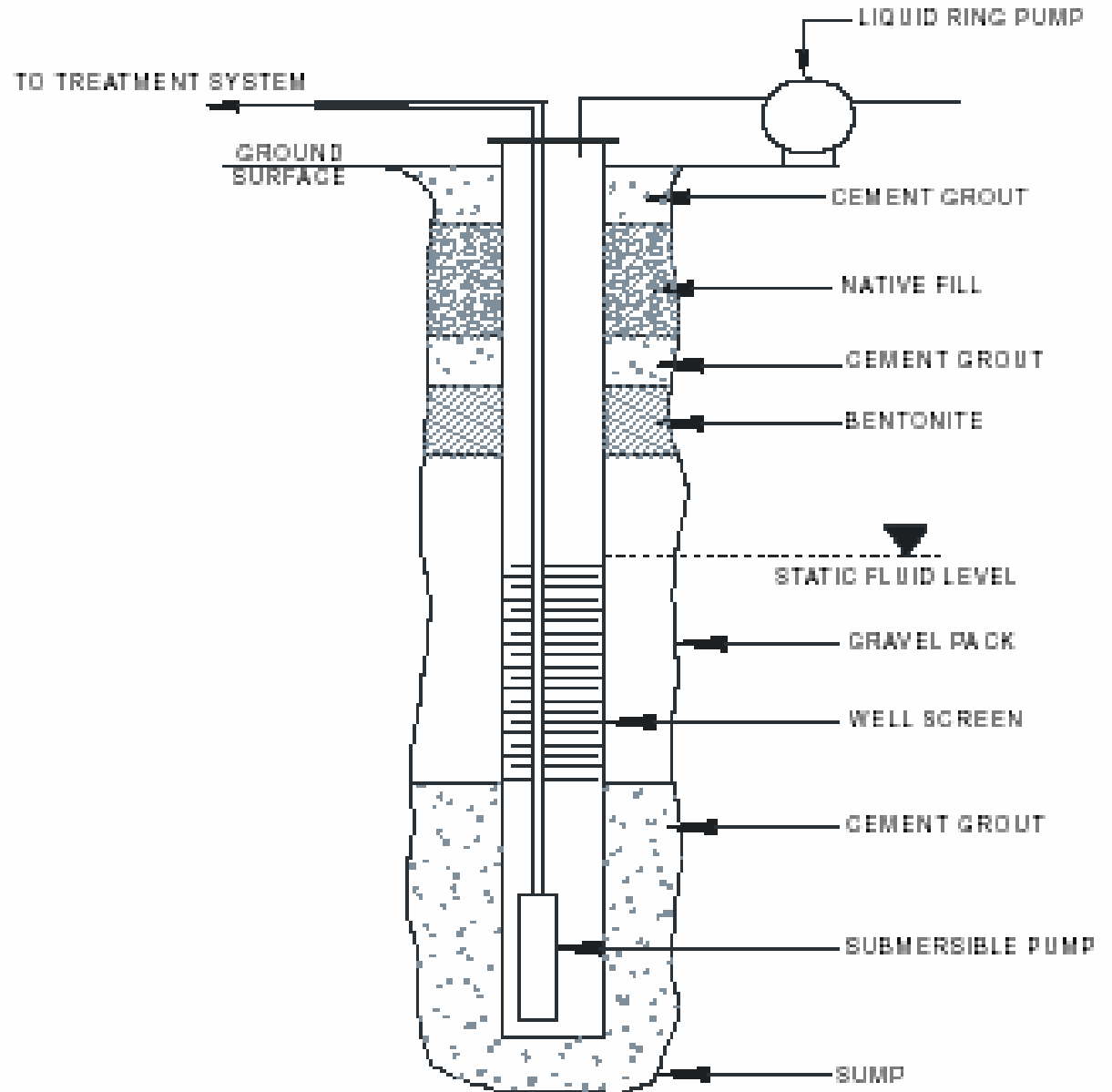

Dual-phase extraction

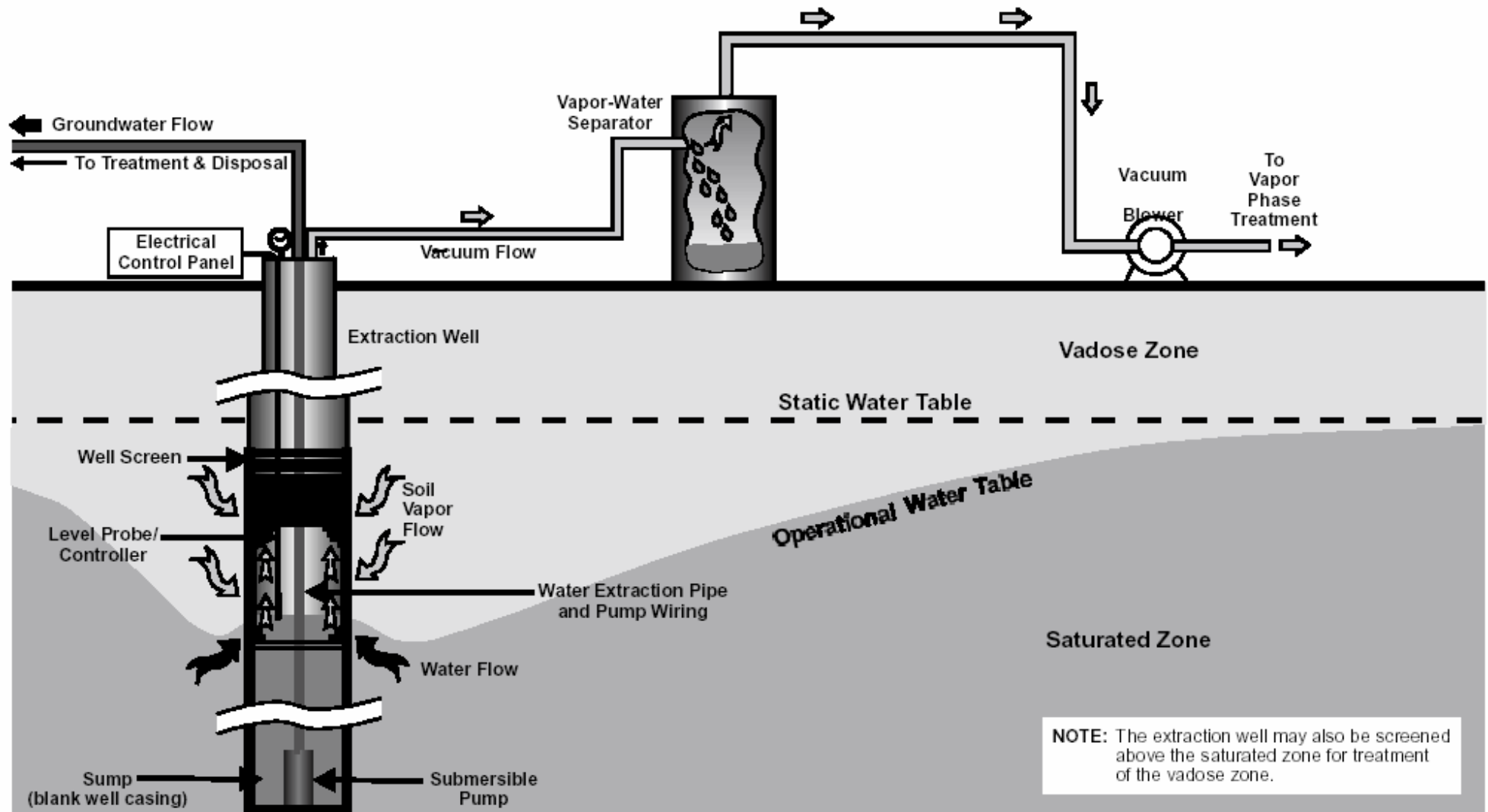

Two-phase extraction

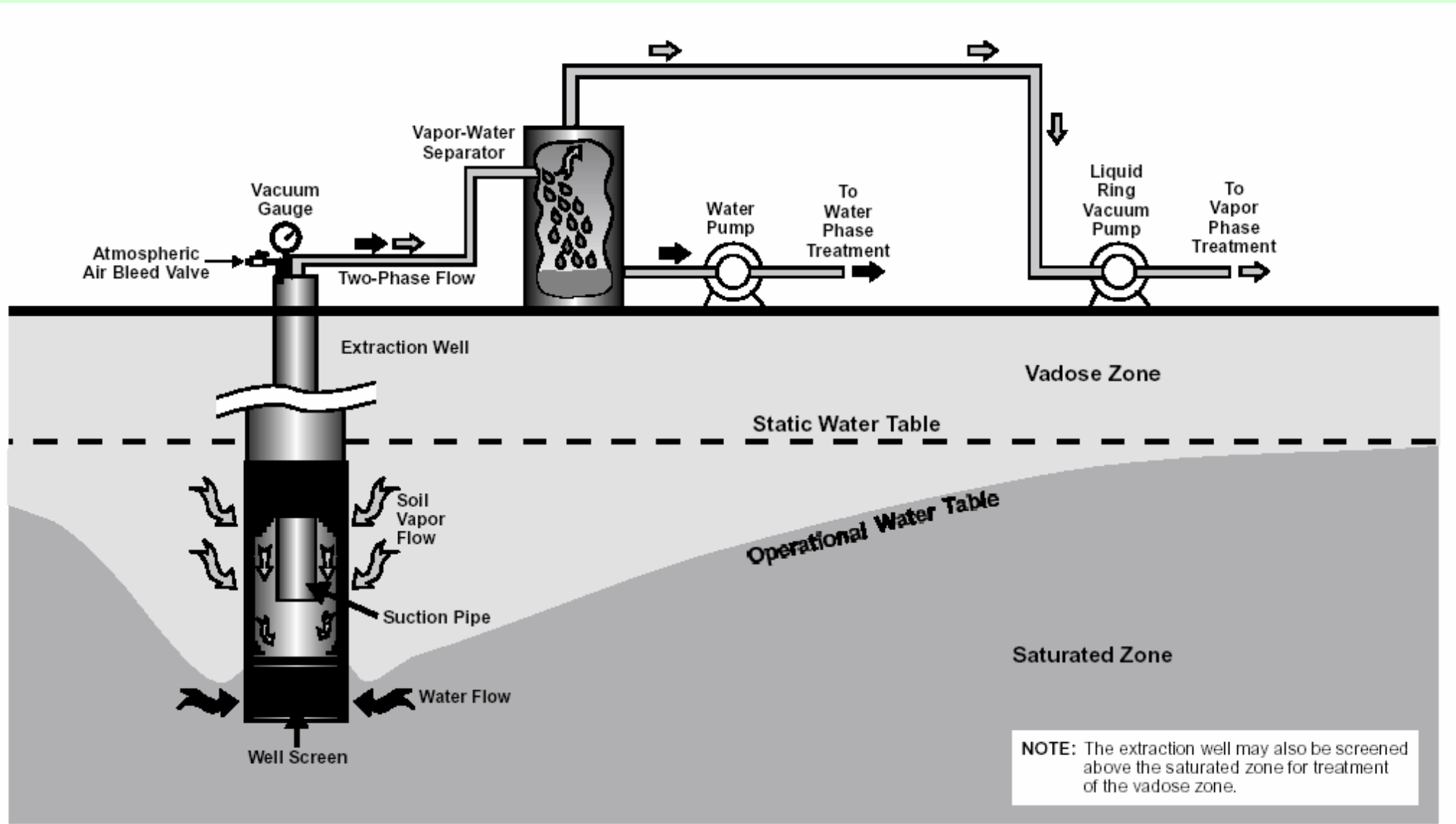

Chemical oxidation

Uses strong oxidizer to chemically destroy contaminants

- Mixed with soil

- Injected into ground water

Oxidating agents:

- Peroxide

- Ozone

- Permanganate

Chemical oxidation

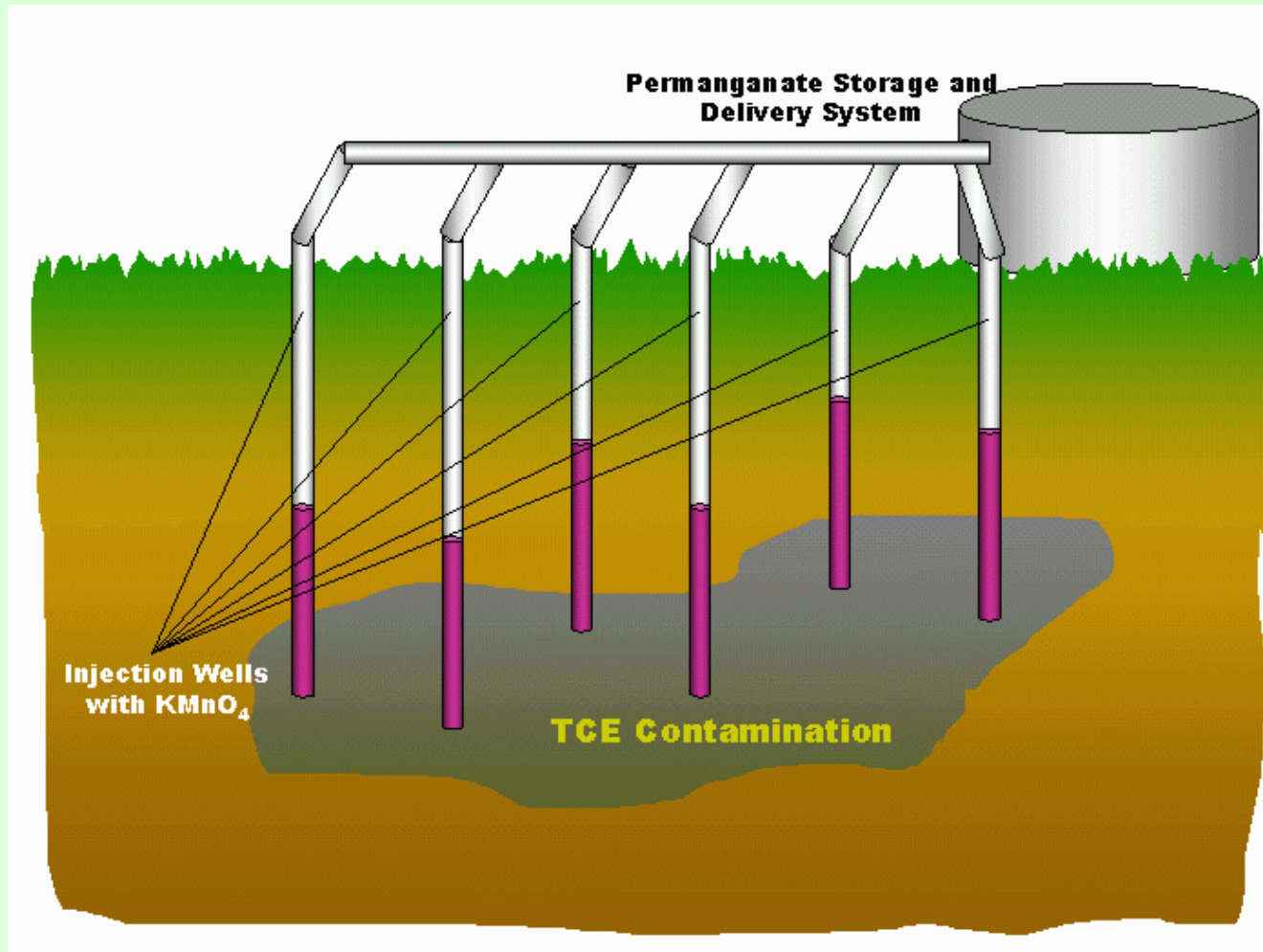

Source: Van Deuren, J., T. Lloyd, S. Chhetry, R. Liou, and J. Peck, 2002. Remediation Technologies Screening Matrix and Reference Guide, 4th Edition. Federal Remediation Technologies Roundtable.

The rate and extent of degradation of a target COC are dictated by the properties of the chemical itself and its susceptibility to oxidative degradation as well as the matrix conditions, most notably, pH, temperature, the concentration of oxidant, and the concentration of other oxidant-consuming substances such as natural organic matter and reduced minerals as well as carbonate and other free radical scavengers. Given the relatively indiscriminate and rapid rate of reaction of the oxidants with reduced substances, the method of delivery and distribution throughout a subsurface region is of paramount importance. Oxidant delivery systems often employ vertical or horizontal injection wells and sparge points with forced advection to rapidly move the oxidant into the subsurface. Permanganate is relatively more stable and relatively more persistent in the subsurface; as a result, it can migrate by diffusive processes. Consideration also must be given to the effects of oxidation on the system. All three oxidation reactions can decrease the pH if the system is not buffered effectively. Other potential oxidation-induced effects include: colloid genesis leading to reduced permeability; mobilization of redox-sensitive and exchangeable sorbed metals; possible formation of toxic byproducts; evolution of heat and gas; and biological perturbation

Oxidizing agents: Peroxide

Peroxide – usually in form of Fenton's reagent:

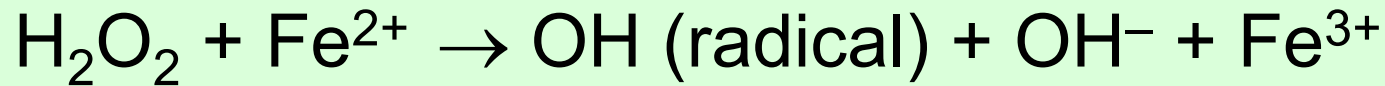
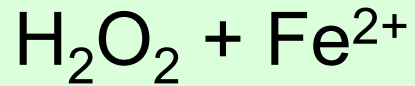

OH radical is extremely strong oxidizer

Net reaction:

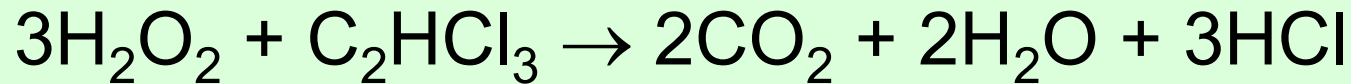

Requires acidic conditions (pH 2 to 4)

Oxidizing agents: Peroxide

Applicability: most organic compounds

Not effective against TCA

Application issues:

Dangerous chemical

Generates large quantities of heat

Generates gases ($\text{CO}_2 + \text{O}_2$)

Other substances may be oxidized, limiting effectiveness

Transport to oxidation site may be limiting

Field trial of Fenton's Reagent

See image in Bryant, J. D. and J. T. Wilson, 1998. "Field Demonstration of In-Situ Fenton's Reagent Destruction of DNAPLS." *Environmental Technology*, Vol. 8, No. 3, Pp. 55-59. May/June 1998.

Oxidizing agents: Permanganate

Usually potassium permanganate:

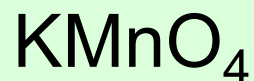

but also Ca, Na, and Mg permanganate

Exact mechanism of oxidation unknown

Net reaction:

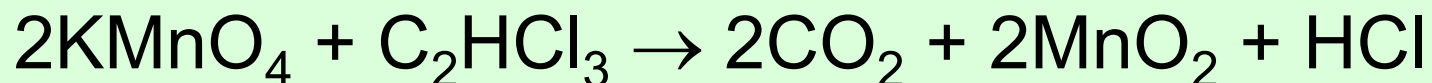

Oxidizer comparison

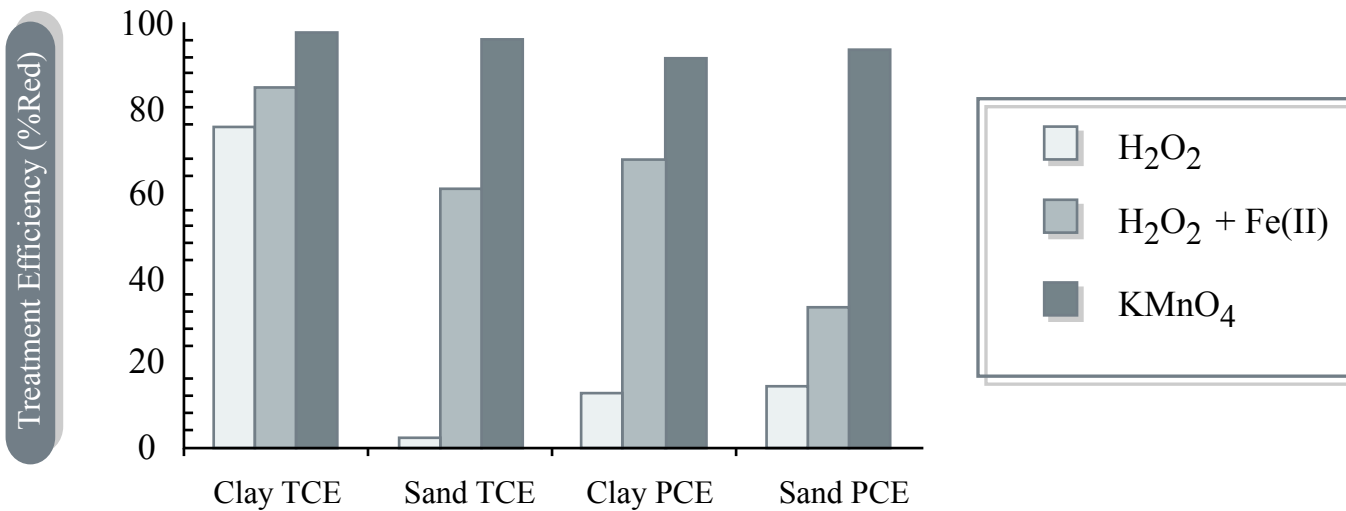

Soil and VOC

Comparison of Soil Treatment with H₂O₂ (25.5 g/kg),
H₂O₂ Plus Iron (25.5 g/kg +5 mM FeSO₄), or KMnO₄ (15.0 g/kg)

Adapted from: Gates-Anderson, D. D., R. L. Siegrist, and S. R. Cline. "Comparison of Potassium Permanganate and Hydrogen Peroxide as Chemical Oxidants for Organically Contaminated Soils." *Journal of Environmental Engineering, ASCE* 127, no. 4 (2001): 337-347. □

Oxidizer comparison

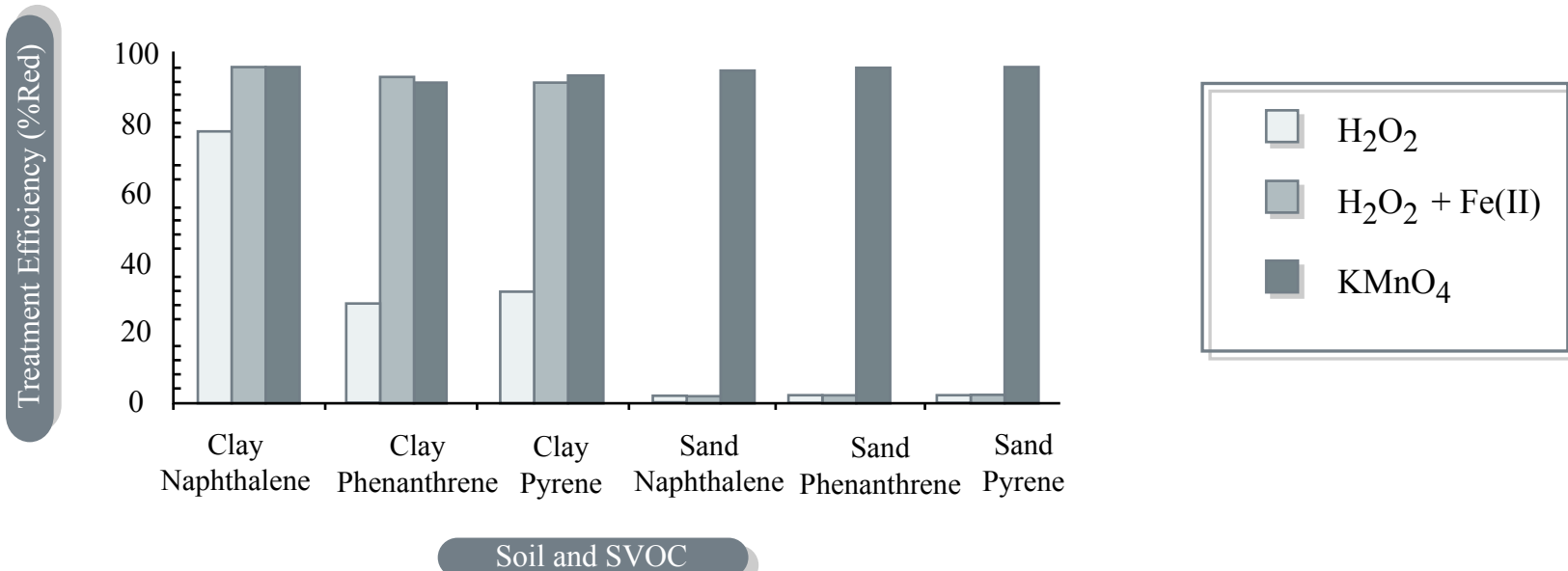

SVOC Treatment Efficiency in Clay Soil Treated for 48 h with H₂O₂ (39 g/kg), H₂O₂ Plus Iron (39 g/kg + 5 mM FeSO₄), or KMnO₄ (16 g/kg)
(Initial Concentrations: Naphthalene = 260-337 mg/kg, Phenanthrene = 248-341 mg/kg, and Pyrene = 226-331 mg/kg)

Adapted from: Gates-Anderson, D. D., R. L. Siegrist, and S. R. Cline. "Comparison of Potassium Permanganate and Hydrogen Peroxide as Chemical Oxidants for Organically Contaminated Soils." *Journal of Environmental Engineering, ASCE* 127, no. 4 (2001): 337-347. □

Oxidizing agents: Ozone

Ozone – O₃

Ozone gas can be injected by sparging

SITE: Superfund Innovative Technology Evaluation Program

The U.S. Environmental Protection Agency's (EPA) Superfund Innovative Technology Evaluation (SITE) - Microsoft Internet Explorer w

File Edit View Favorites Tools Help

Back Forward Stop Home Search Favorites History Print Copy Paste Address http://www.epa.gov/ORD/SITE/ Go Links



What's New?

Technology Profiles

Highlights

Project Status

Documents

SITE Reports

Bilateral Agreement

Introduction to the SITE Program

The U.S. Environmental Protection Agency's (EPA) Superfund Innovative Technology Evaluation (SITE) Program was established by EPA's Office of Solid Waste and Emergency Response and the Office of Research and Development (ORD) in response to the 1986 Superfund Amendments and Reauthorization Act, which recognized a need for an "Alternative or Innovative Treatment Technology Research and Demonstration Program." The SITE Program is administered by ORD National Risk Management Research Laboratory in the Land Remediation and Pollution Control Division (LRPCD), headquartered in Cincinnati, Ohio.

New Solicitations

Updated March 13, 2002

[NEW SITE Program Solicitations "New for 2002"](#)

Hot Links

[Small Business Innovation Research](#)

[NRMRL's Land Remediation & Pollution Control Division](#)

[U.S. EPA Office of Prevention, Pesticides and Toxic Substances](#)

[U.S. EPA/Technology Innovation Office \(TIO\)](#)

[U.S. EPA/Superfund](#)

Federal Remediation Technologies Roundtable

The screenshot shows a Microsoft Internet Explorer browser window with the address bar displaying <http://www.frtr.gov/matrix2/section1/toc.html>. The page title is "Table of Contents - Microsoft Internet Explorer with iHarvest One". The main content area features the FTR logo and the title "Remediation Technologies Screening Matrix and Reference Guide, Version 4.0". A navigation bar includes links for "Previous Section", "Top Page", "Screen Matrix", "Table of Contents", "Synonym List", and "Next Section". A left sidebar contains a vertical menu with links for "Home", "Table of Contents", "Introduction", "Contaminants", "Treatments/Profiles", "References", "Appendices", and "Navigation". The main content area is titled "Table of Contents" and contains a table of contents grid, a preface section, and sections 1 and 2 with their respective sub-sections and lists of figures and tables.

FTR
Remediation Technologies Screening Matrix
and Reference Guide, Version 4.0

Previous Section Top Page Screen Matrix Table of Contents Synonym List Next Section

Home
Table of Contents
Introduction
Contaminants
Treatments/Profiles
References
Appendices
Navigation

Section 1: Introduction	Section 2: Contaminant Perspectives	Section 3: Treatment Perspectives
Section 4: Treatment Technology Profiles	Section 5: References	Appendices
List of Figures	List of Tables	List of Acronyms

PREFACE

- [Notice](#)
- [Foreword](#)
- [Report Documentation Page](#)
- [Acknowledgment](#)

1 INTRODUCTION

- [1.1 Objectives](#)
- [1.2 Background](#)
- [1.3 How To Use This Document](#)
- [1.4 Requirements To Consider Technology's Impact on Natural Resources](#)
- [1.5 Cautionary Notes](#)
- [1.6 On Line Survey](#)

2 CONTAMINANT PERSPECTIVES

- [2.1 Presumptive Remedies](#)
- [2.2 Data Requirements](#)

List of Figures in Section 1
List of Tables in Section 1

List of Figures in Section 2
List of Tables in Section 2

TechDirect Newsletter

TechDirect, May 1, 2002 - Message (Plain Text)

File Edit View Insert Format Tools Actions Help

Type a question for help

Reply Reply to All Forward

This message has extra line breaks. To remove, click here.

From: techdirect@valley.rtpnc.epa.gov on behalf of Heimerman,Jeff@epamail.epa.gov Sent: Wed 5/1/2002 2:18 PM

To: Multiple recipients of list

Cc:

Subject: TechDirect, May 1, 2002

Welcome to TechDirect. Since the April 1 message, TechDirect gained 300 new subscribers for a total of 13,681. If you feel the service is valuable, please share TechDirect with your colleagues. Anyone interested in subscribing to TechDirect may do so on CLU-IN at <http://clu-in.org/techdirect> . All previous TechDirect messages are archived there.

Mention of non-EPA documents or presentations does not constitute a U.S. EPA endorsement of their contents, only an acknowledgment that they exist and may be relevant to the TechDirect audience.

New Video

Introduction to Environmental Geophysics. This video, produced by the U.S. EPA Environmental Response Team, is designed for individuals who have the responsibility for overseeing or planning the collection of site data or waste characteristics. It stresses practical information required to design or supervise geophysical surveys at hazardous waste sites. Run time 9 minutes. See the video section <http://clu-in.org/studio>

Documents and Websites

Risk Assessment Guidance for Superfund Volume III Part A: Process for Conducting Probabilistic Risk Assessment (RAGS 3a) (OSWER 9285.7-45). This guidance document was issued by the U.S. EPA Office of Emergency and Remedial Response. It was created to establish national criteria to conduct, and review Superfund probabilistic risk assessments in response to the October 1995 Superfund Reform #6A. RAGS 3A was designed to address both human health and ecological probabilistic risk assessments (PRA). It provides flexibility and maintains national consistency in selecting the preliminary remediation goal, based on

Cost estimating resources

- CLU-IN Web Site

<http://www.clu-in.org/>

- EPA reports

- Historical cost analysis system (HCAS)

http://globe.lmi.org/lmi_hcas/

- Environmental Cost-Handling Options and Solutions (ECHOS) – R.S. Means Company

Technical impracticability

Guidance for Evaluating the Technical Impracticability of Ground-Water Restoration

Interim Final

Office of Solid Waste and Emergency Response
U.S. Environmental Protection Agency
Washington, DC 20460

EPA Directive

“EPA’s goal of restoring contaminated ground water within a reasonable timeframe at Superfund or RCRA sites will be modified where **complete** restoration is found to be technically impracticable. In such cases, EPA will select an alternative remedial strategy that is **technically practicable, protective of human health and the environment**, and satisfies the statutory and regulatory requirements of the Superfund or RCRA programs as appropriate.”

TI Requirements

Identify ARARs to be waived

Specify spatial extent for TI waiver

Develop site conceptual model

Provide thorough characterization of site

Evaluate restoration potential

Provide cost estimates

Evaluation of restoration potential

Source control measures

TI waiver for ground water requires demonstration of source control

Remedial action performance analysis

High quality, detailed ground-water monitoring

Effective operation of existing ground-water remedy

Evaluate remedy modifications

Evaluate trends over time

REILLY TAR & CHEMICAL SITE

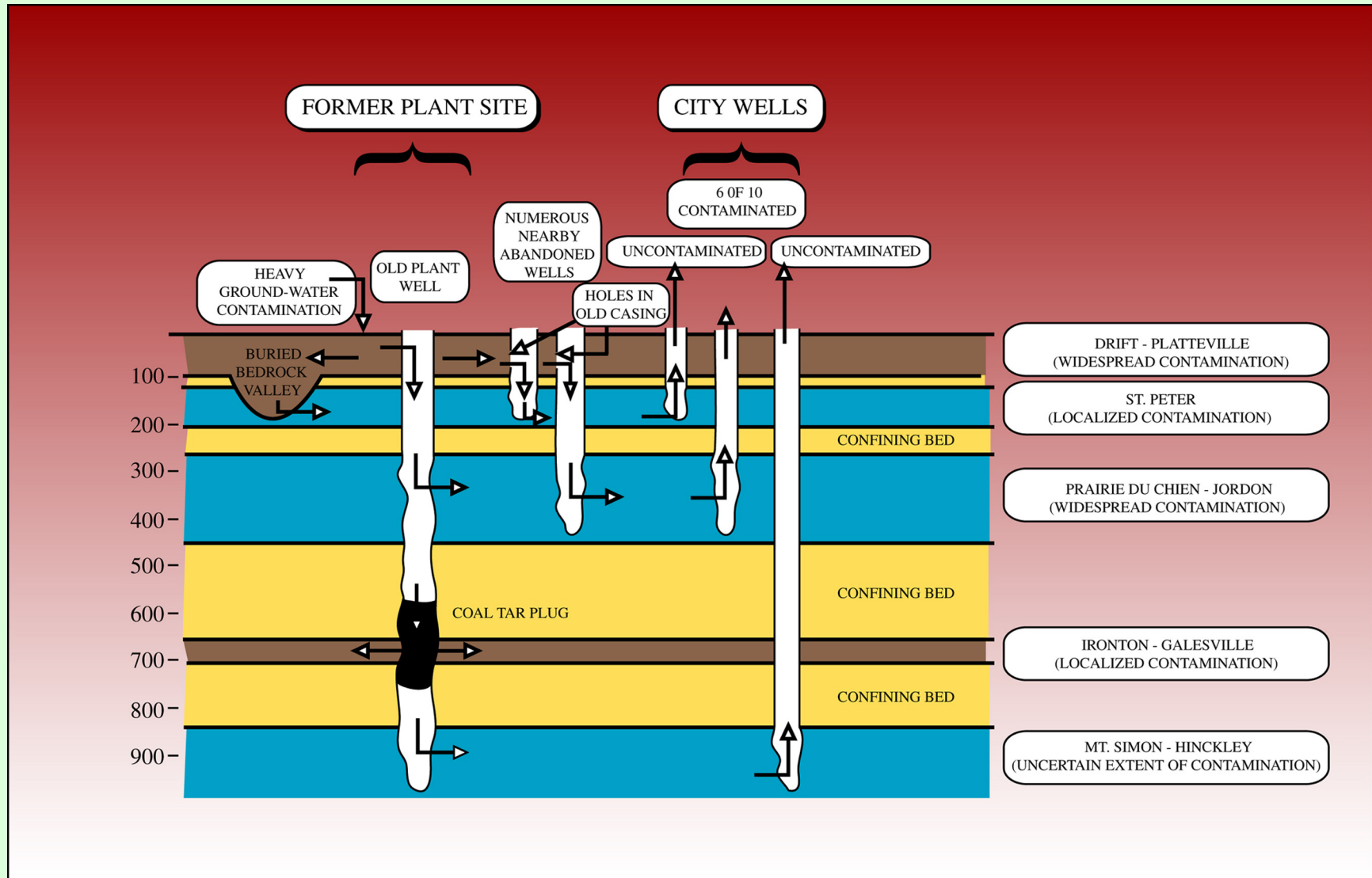

Gasoline Additives

Introduced in late 1970s during phase-out of lead additives

Two uses:

Oxygenated fuel (oxyfuel) – promotes more complete combustion of hydrocarbons

Reformulated gasoline – reduced benzene and aromatics to reduce ozone formation for air quality

Gasoline Oxygenates

Oxygenates:

MTBE – methyl tert butyl ether

ethanol

ethyl tert butyl ether

methanol

tertiary butyl alcohol – TBA

Oxinol™ – blend of methanol and TBA

Increase octane rating of gasoline

Reduce emissions of air pollutants

Growth in use of MTBE

1960s – first formulated by ARCO

1970 – 39th highest production organic chemical

1998 – 4th highest production

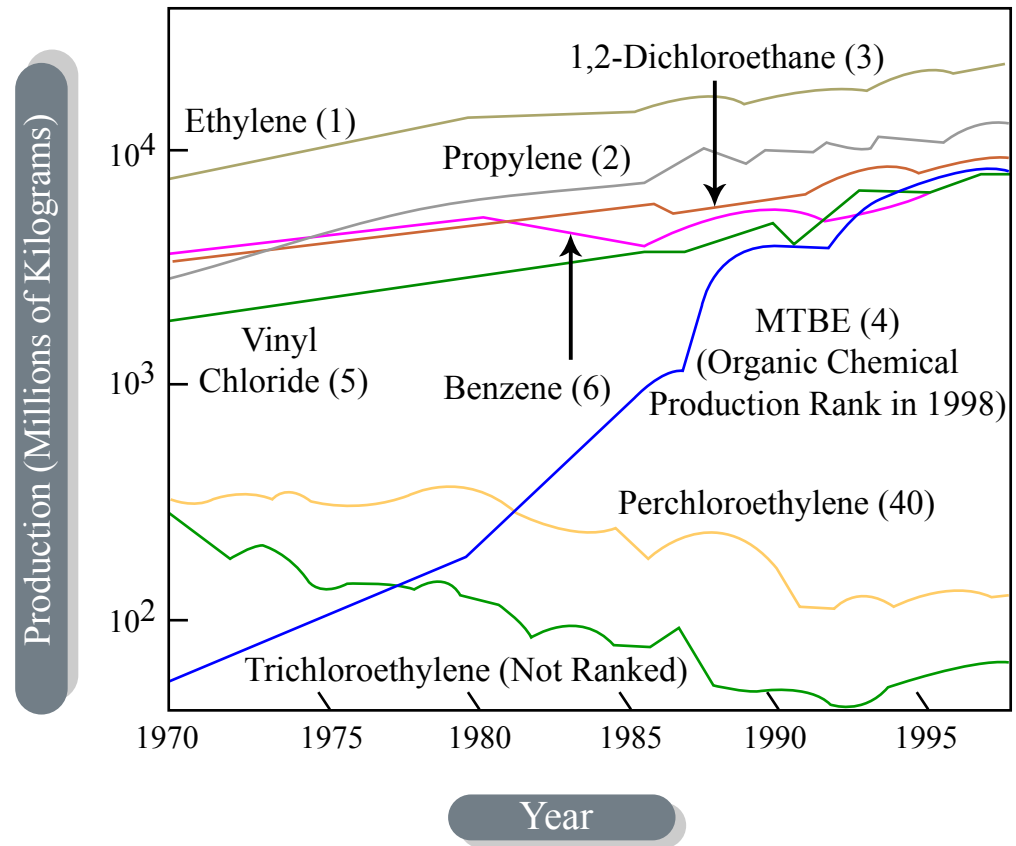

Adapted from: Johnson, R., J. Pankow, D. Bender, C. Price, and J. Zogorski. "MTBE, To What Extent Will Past Releases Contaminate Community Water Supply Wells?" *Environmental Science & Technology* 34, no. 9 (May 1, 2000): 210 A-217 A.

Use of MTBE

Used in 13 states as oxyfuel

- 3% of all oxyfuel

- 10-15% by volume of oxyfuel gasoline

Used in 18 states as reformulated gas

- 85% of all RFG

- 11-15% by volume of RFG gasoline

Present in most parts of country as part of gasoline product stream

- 88% of Kansas UST sites

Methyl tertiary Butyl Ether - MTBE

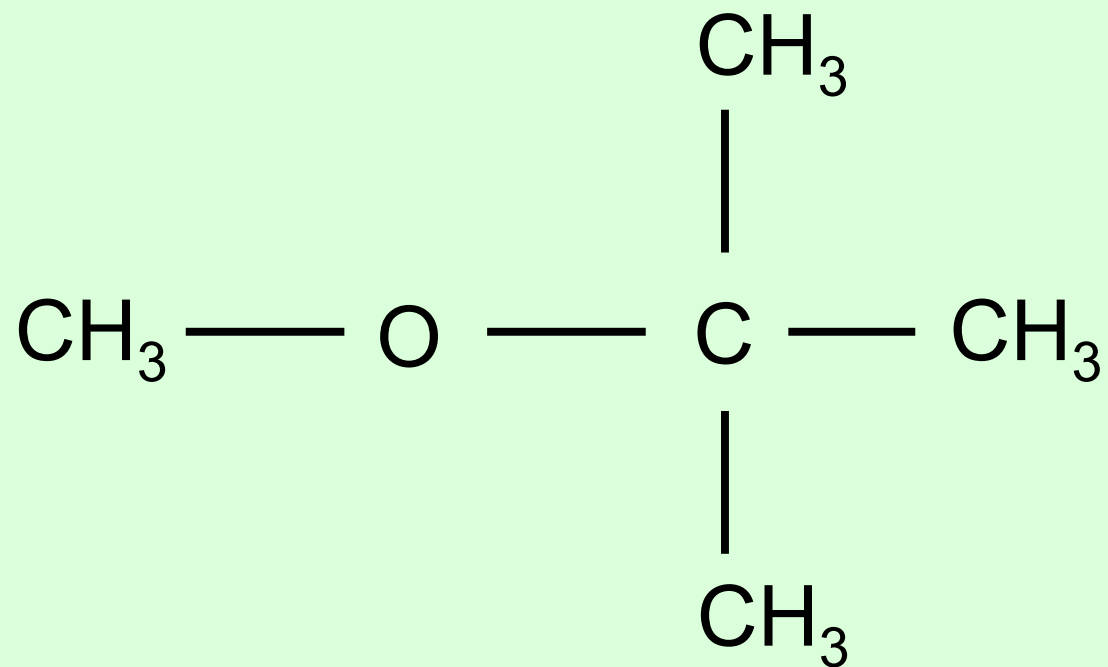

MTBE Properties

Extremely soluble:

4700 mg/L from RFG

6300 mg/L from oxyfuel

Versus BTEX from conventional gasoline:

18 mg/L benzene

25 mg/L toluene

3 mg/L ethylbenzene

20 mg/L total xylenes

MTBE Properties

Very low solid partition coefficient ($R_d \cong 1$)

Does not biodegrade readily

Possible human carcinogen

Drinking water advisory – 20 to 40 $\mu\text{g/L}$

Not highly volatile

Readily partitions from atmosphere to precipitation

Difficult to treat

Prevalence of MTBE

Found at background concentrations of 0.2 to 3 $\mu\text{g}/\text{L}$ due to prevalence in precipitation

In USGS national surveys:

- Found above detection limit in 83% of stormwater samples

- Found in 27% of ground-water samples

Found at large majority of LUST sites

Significant problems in California including high concentration in Santa Monica public supply wells

Example MTBE Site

Leak in tank valve at fuel storage facility,
Woodbury, New Jersey

Hydrogeology: silty sands of moderate
hydraulic conductivity

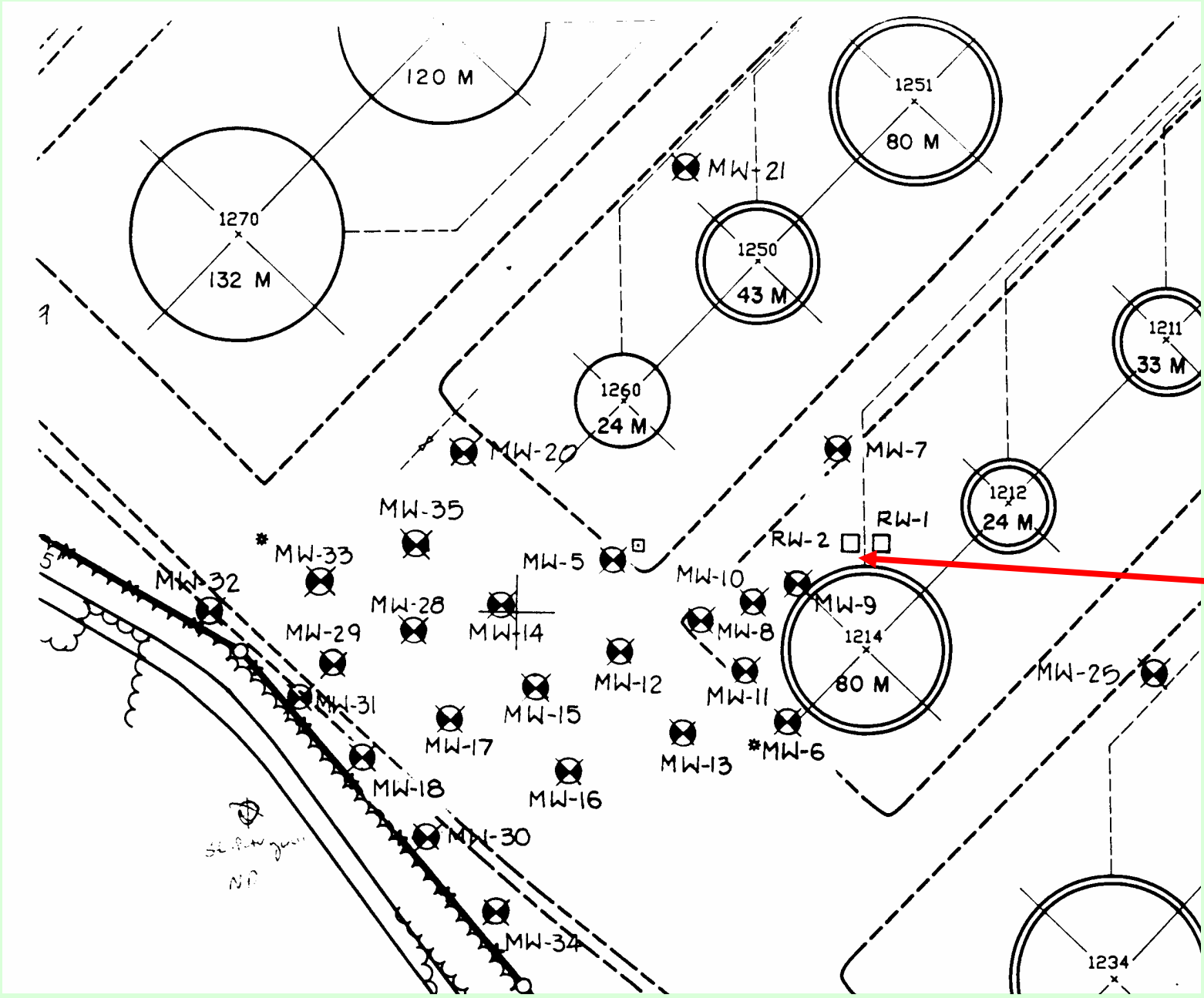

Feb. 1992
Initial
release

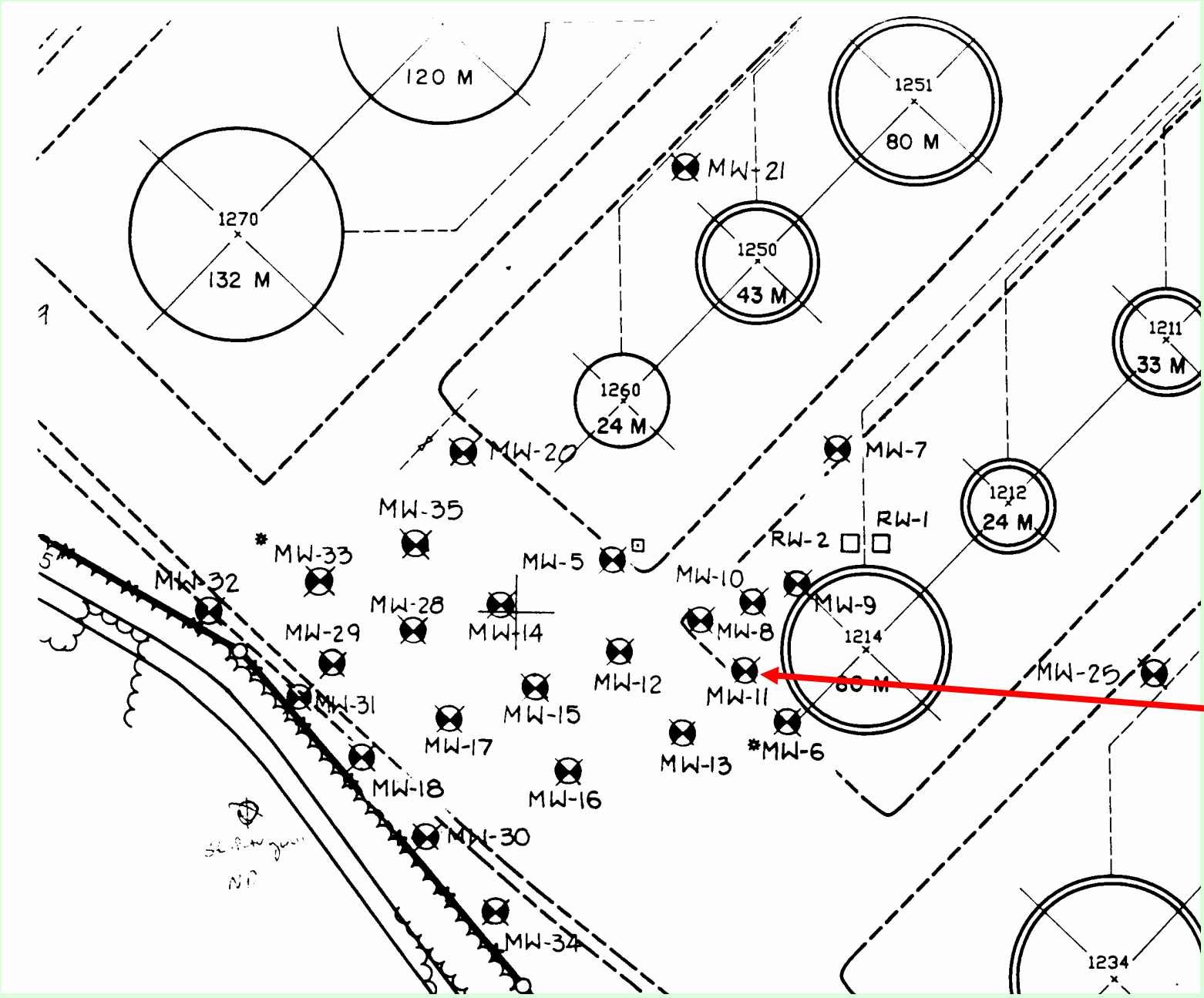

Dec. 1992
MTBE = 18 ug/L
BTEX < 1 ug/L

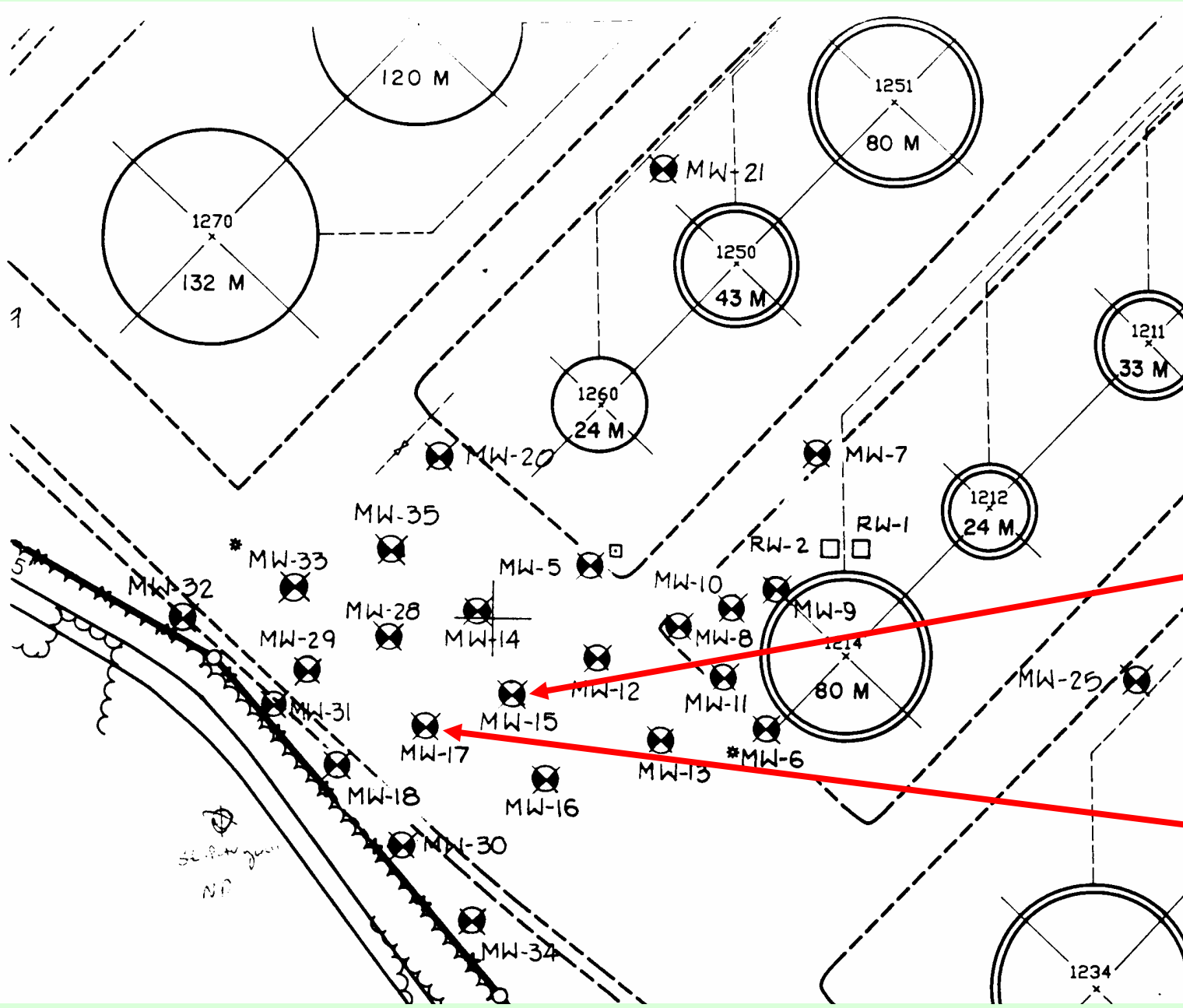

Feb. 1993
MTBE = 490 ug/L
BTEX = 27 ug/L

MTBE = 63 ug/L
BTEX < 4 ug/L

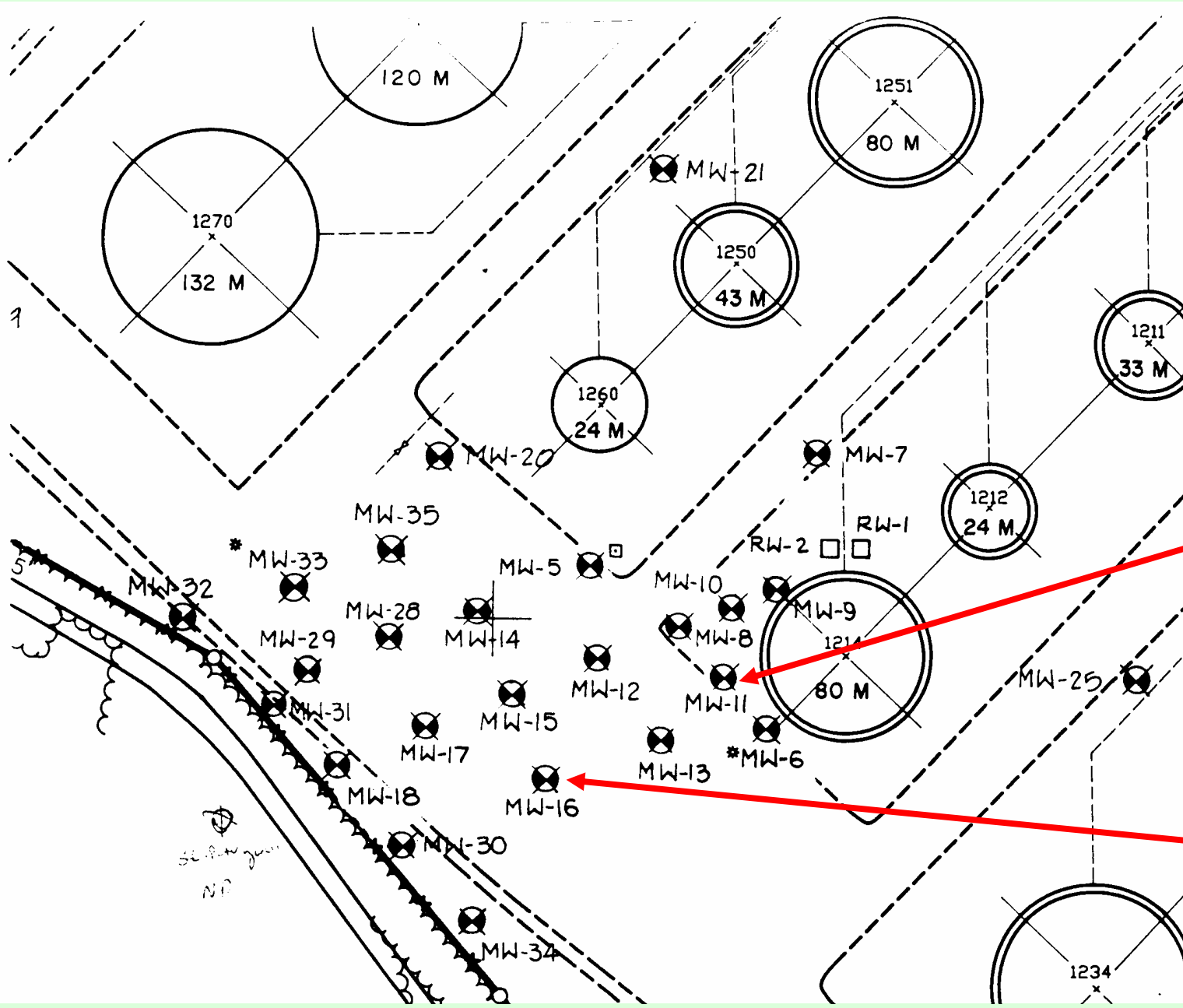

June 1993
MTBE = 190 ug/L
BTEX = 2700 ug/L

MTBE = 1.9 ug/L
BTEX < 4 ug/L

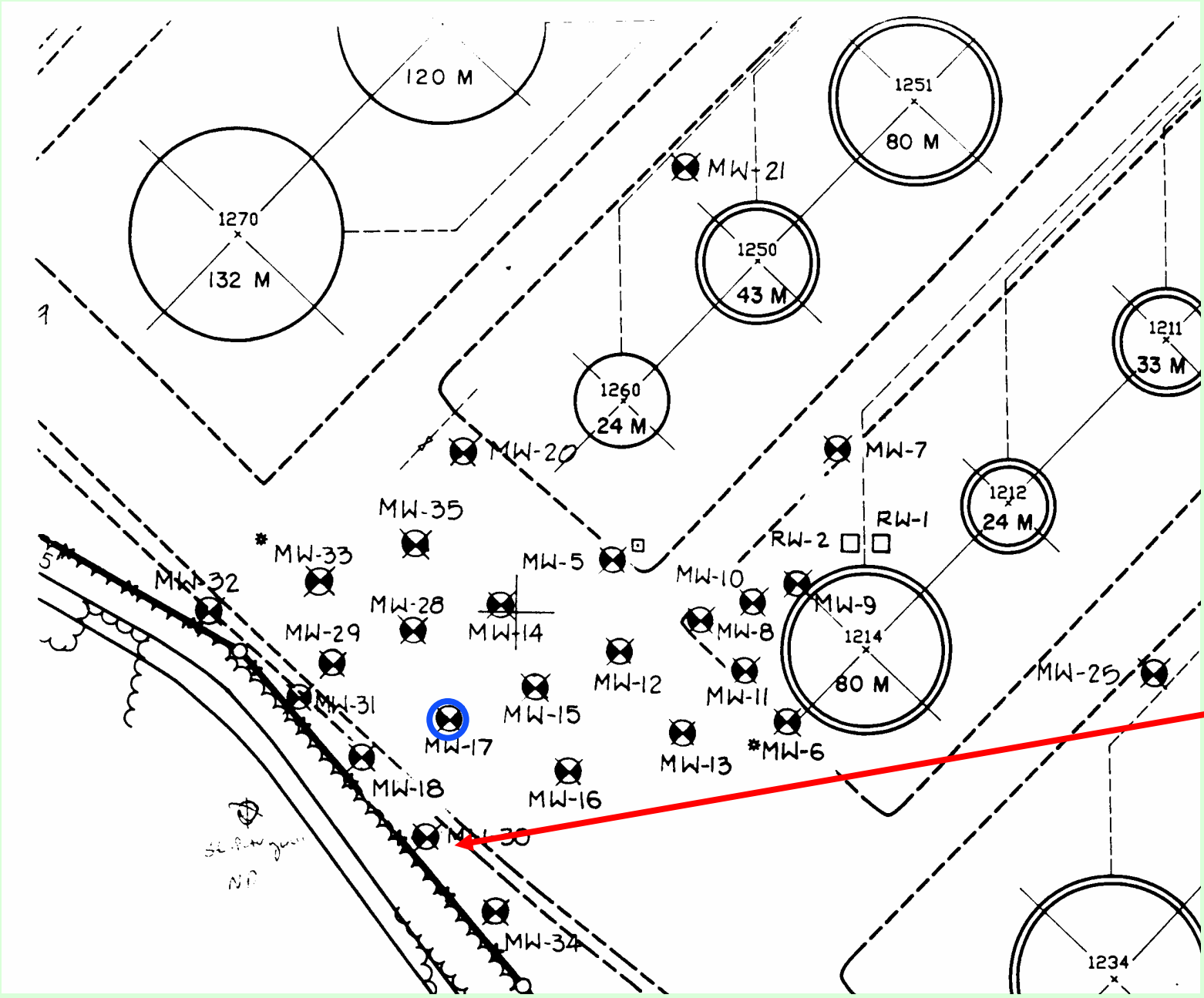

Nov. 1993
MTBE = 15 ug/L
BTEX < 4 ug/L