

Genetics and  
Parkinson's disease:  
an introduction

July 19, 2006

# PD and heredity

- The cause of Parkinson's disease has traditionally been associated to environmental factors
  - estimates of relative risk have tended to be low and varied widely between studies (2-15%)
  - twin studies have demonstrated a low concordance in monozygotic and dizygotic twins
  - post-encephalitic PD variant showed convincing evidence of environmental susceptibility
  - MPTP-induced parkinsonism further shifted viewpoints away from heredity
  - familial aggregation has often been attributed to shared environmental factors
- Monogenic forms of PD do share similar characteristics to sporadic PD, however, including parkinsonism and selective SNc neurodegeneration; common pathway?
- Incomplete penetrance of some genetic components, and relatively high rates of “risk factor” mutations in sporadic PD points to a multifactoral explanation for neurodegeneration in PD
- Today there are at least 10 distinct genetic loci associated with PD

# Useful Terms - thanks Sue!

- **polymorphism** - a naturally occurring variation in the sequence of genetic information on a segment of DNA among individuals; a genetic characteristic with more than one common form in a population
- **mutation** - a variant allele that occurs in less than 1% of the population
- **allele** - each person inherits two alleles for each gene, one allele from each parent; these alleles may be the same or may be different from one another
  - **homozygous mutation:** ▪ both alleles contain the same mutation
  - **heterozygous mutation:** one allele contains the mutation
  - **compound heterozygous mutation:** each allele has a different mutation
- **protein domain** - a region of conserved, specific functionality within a protein
- **gain-of-function** - when a mutation increases the rate of or propensity for protein function
- **loss-of-function** - when a mutation decreases the normal functioning of a protein

# Genetic Primer

- “Central dogma” of molecular biology: DNA → RNA → protein
- Eukaryotic genes contain both coding regions (exons) and non-coding regions (introns); introns are removed prior to translation
- Proteins are assembled based on sequential information in mRNA
- mRNA nucleotides (A, G, C, U) are “read” in codons - 3-nucleotide sequences that define an open reading frame (ORF)

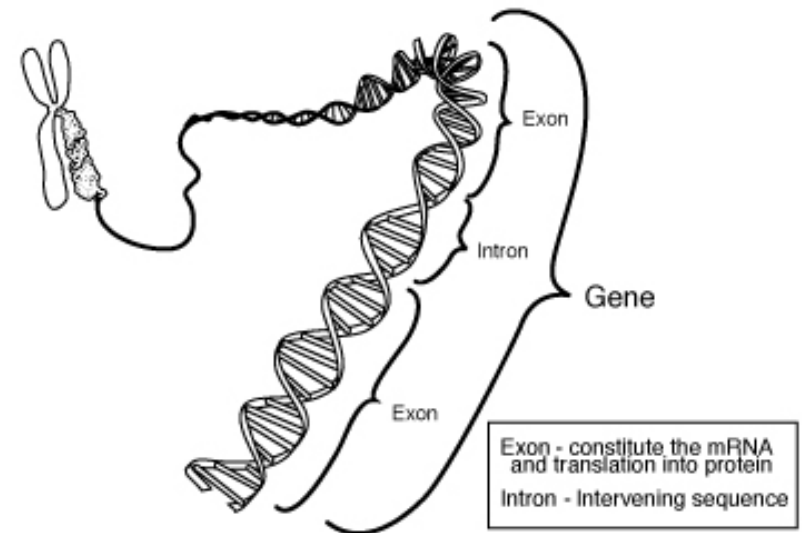

1st base	2nd base in the codon				3rd base
	U	C	A	G	
U	Phenylalanine	Serine	Tyrosine	Cysteine	U
	Phenylalanine	Serine	Tyrosine	Cysteine	C
	Leucine	Serine	Stop	Stop	A
	Leucine	Serine	Stop	Trptophan	G
C	Leucine	Proline	Histidine	Arginine	U
	Leucine	Proline	Histidine	Arginine	C
	Leucine	Proline	Glutamine	Arginine	A
	Leucine	Proline	Glutamine	Arginine	G
A	Isoleucine	Threonine	Asparagine	Serine	U
	Isoleucine	Threonine	Asparagine	Serine	C
	Isoleucine	Threonine	Lysine	Arginine	A
	Isoleucine	Threonine	Lysine	Arginine	G
G	Valine	Alanine	Aspartic Acid	Glycine	U
	Valine	Alanine	Aspartic Acid	Glycine	C
	Valine	Alanine	Glutamic Acid	Glycine	A
	Valine	Alanine	Glutamic Acid	Glycine	G

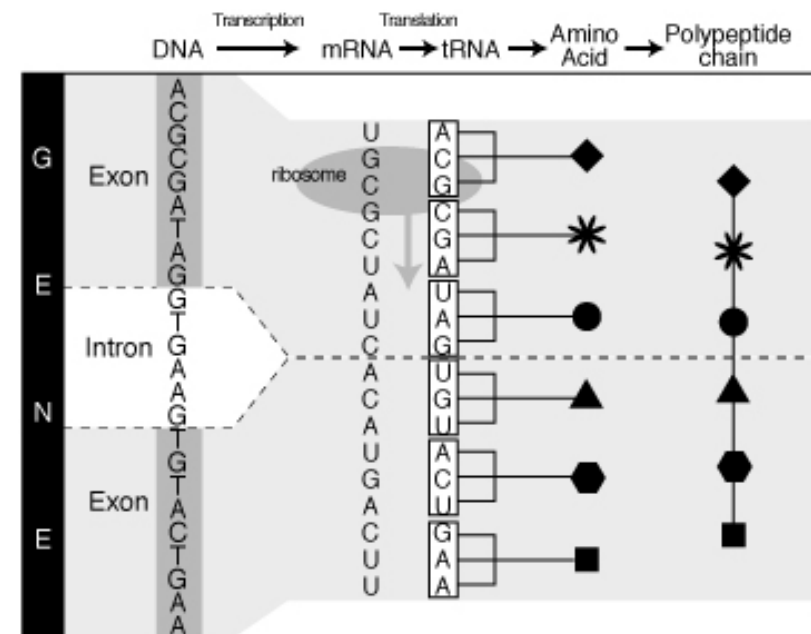

# Proteins

- Protein function is dictated by protein structure and folding
- Mutations that change the primary structure of a protein can affect higher levels of protein structure (2nd, 3rd, 4th)
- Changes in protein structure will most likely lead to changes in protein function (either loss-of-function or gain-of-function)
- Protein function is inherently based on structure; structure is defined by mRNA and ORF
- Humans are diploid; often one allele is able to compensate for the other
  - homozygous: both alleles are affected
  - heterozygous: only one allele is affected
  - compound heterozygous: each allele has a different mutation

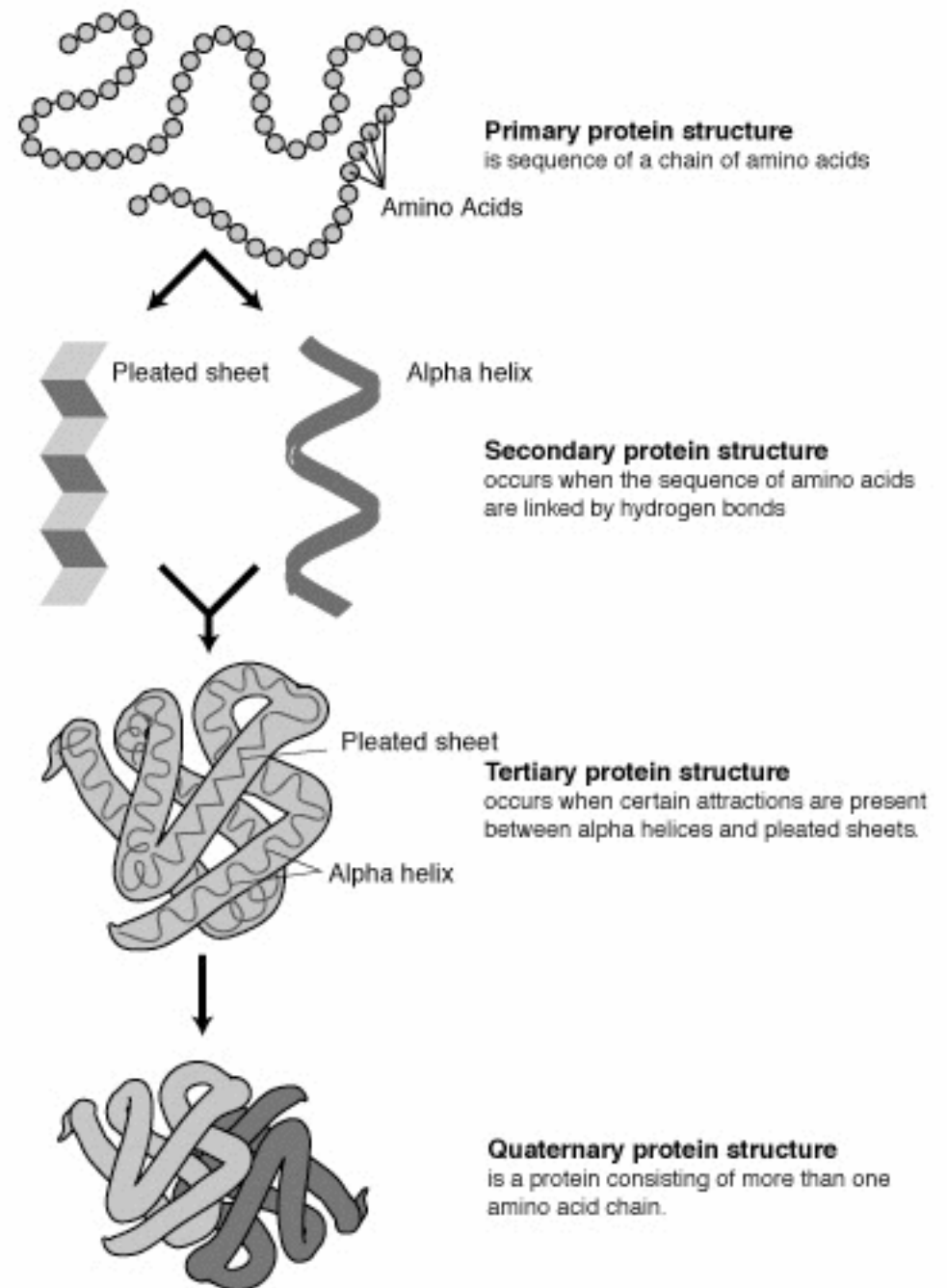

# Point mutations: missense and nonsense

- Most common forms of mutation
- Missense mutations can lead to changes in protein function (detrimental or beneficial)
- Nonsense mutations almost invariably lead to protein dysfunction

## Missense mutation

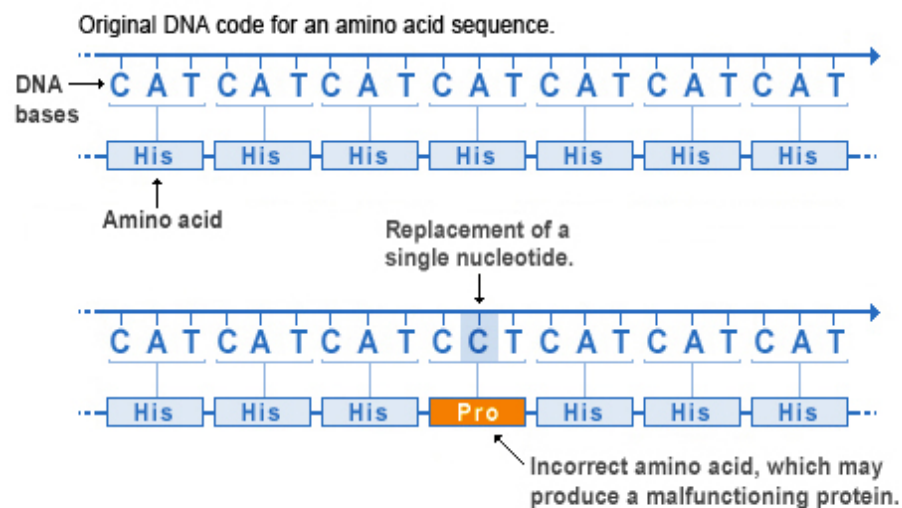

## Nonsense mutation

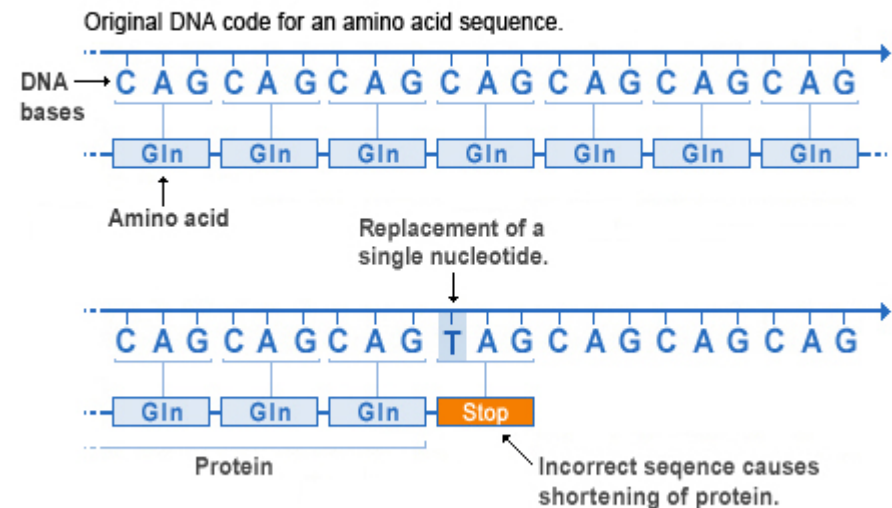

# mutations: insertion and deletion

- DJ1 (PARK7)
- Typically more deleterious than missense/substitution mutations
- Insertion or deletion of 1 or 2 nucleotides will lead to a frameshift - a change of ORF - that will almost certainly be detrimental to protein function

## Insertion mutation

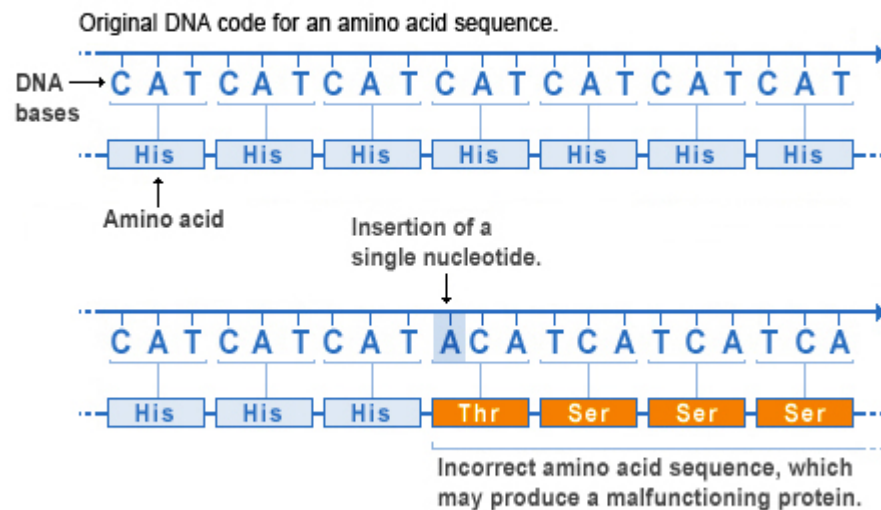

## Deletion mutation

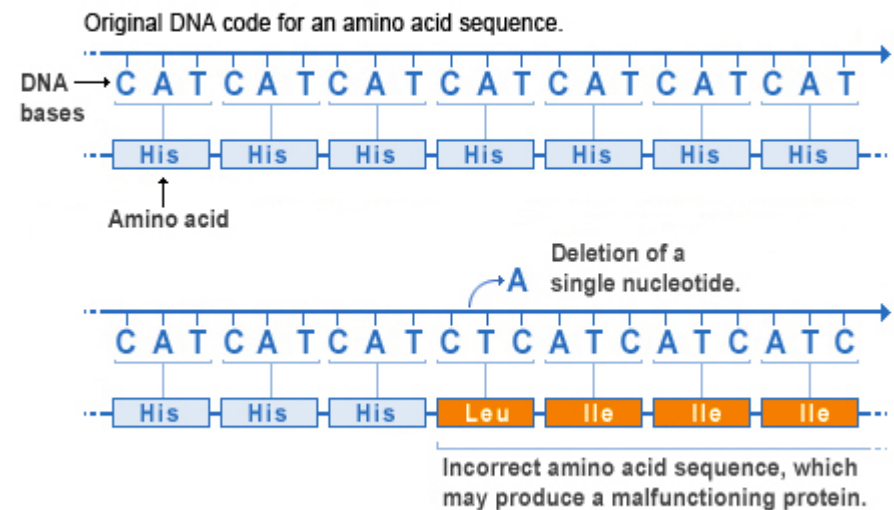

## Frameshift mutation

Original DNA code for an amino acid sequence.

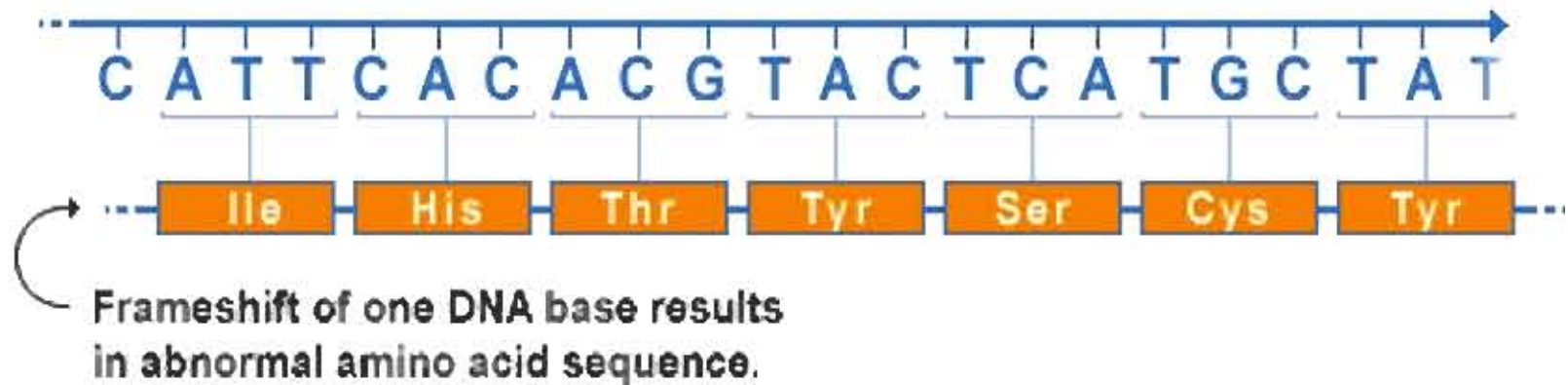
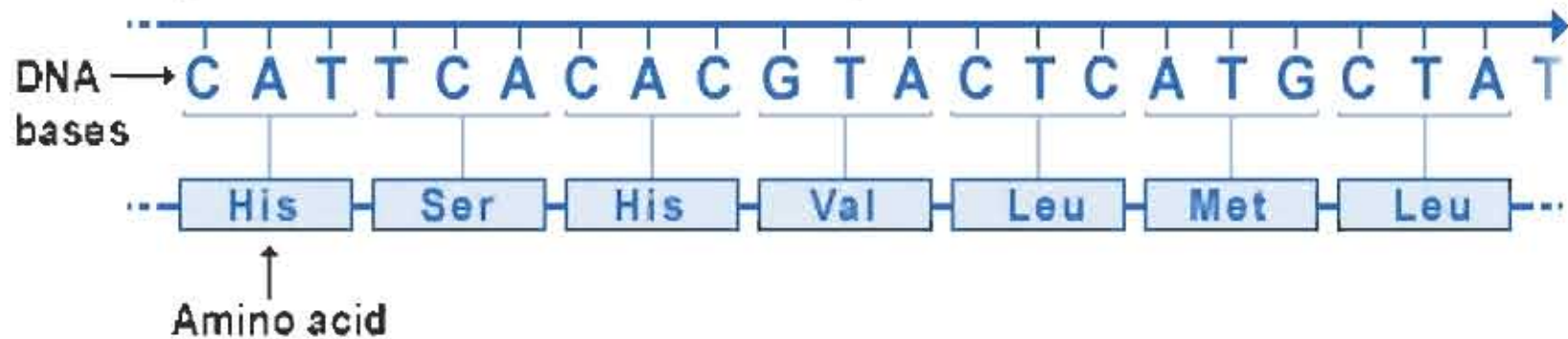



# Duplication mutations

- SNCA (PARK1 and PARK4), parkin (PARK2)
- can occur at any level, from a single exon to entire portions of chromosomes

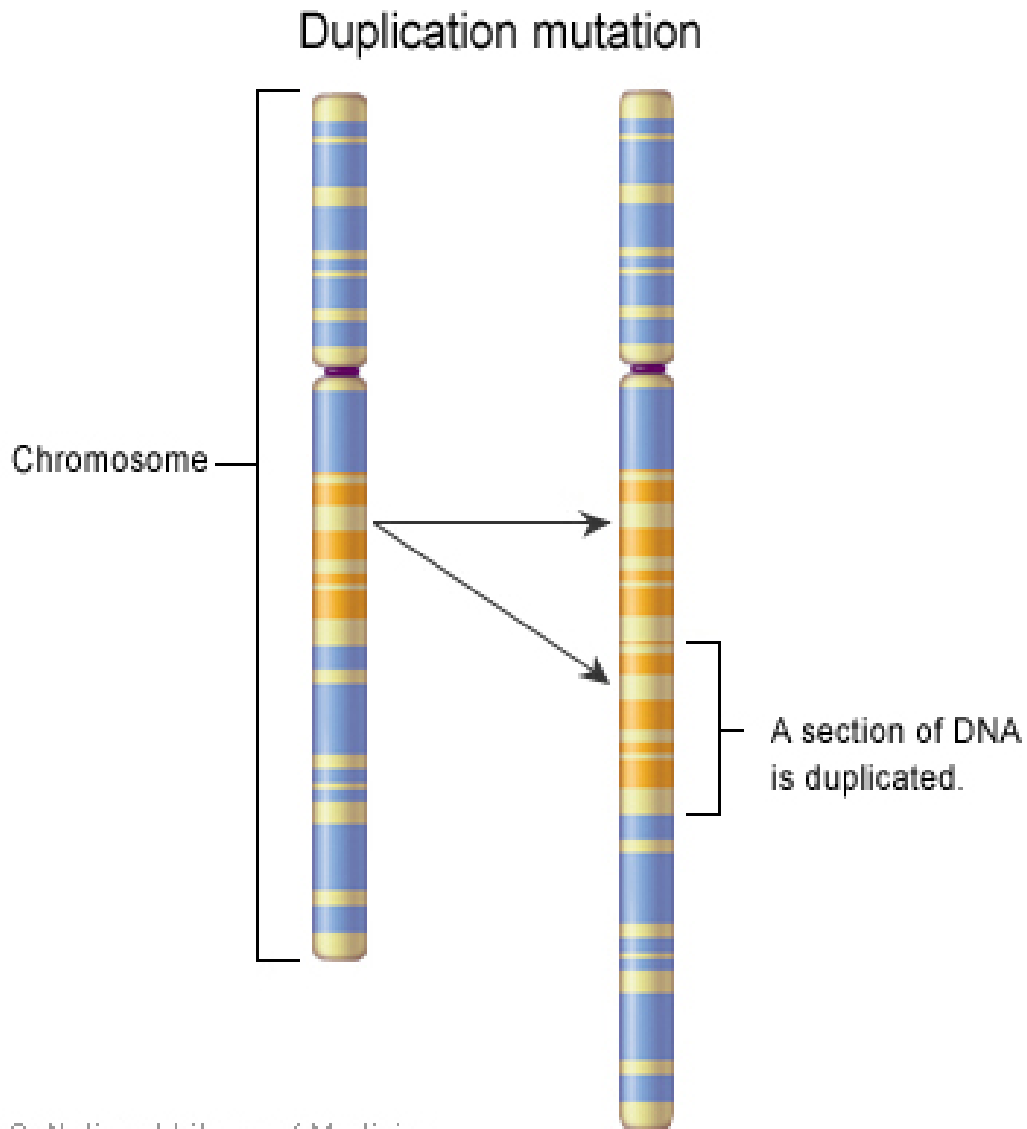

# $\alpha$ -synuclein (PARK1, PARK4)

- First gene to be implicated in PD (SNCA)
- 140 AA soluble protein of unknown function; wild-type protein inhibits phospholipase D2 (signal transduction, membrane vesicle trafficking, cytoskeletal dynamics) and is a competitive inhibitor of TH
- Missense mutations identified in Italian-American (A53T), German (A30P), and Spanish (E46K) families with autosomal dominant PD; associated with toxic gain-of-function; these mutations are not present in sporadic PD or individuals without disease
- Duplications and triplications have been implicated in PDD and DLB; individuals with SNCA multiplications present symptoms similar to sporadic PD, but are prone to dementia and autonomic dysfunction
- Dosage of gene is directly related to age of onset of PD (38-65 years for duplications, 24-48 years for triplications)
- $\alpha$ -synuclein binds preferentially to plasma membrane; cytosolic  $\alpha$ -synuclein (from over-expression or loss of affinity with membrane) can form aggregates, possibly Lewy bodies

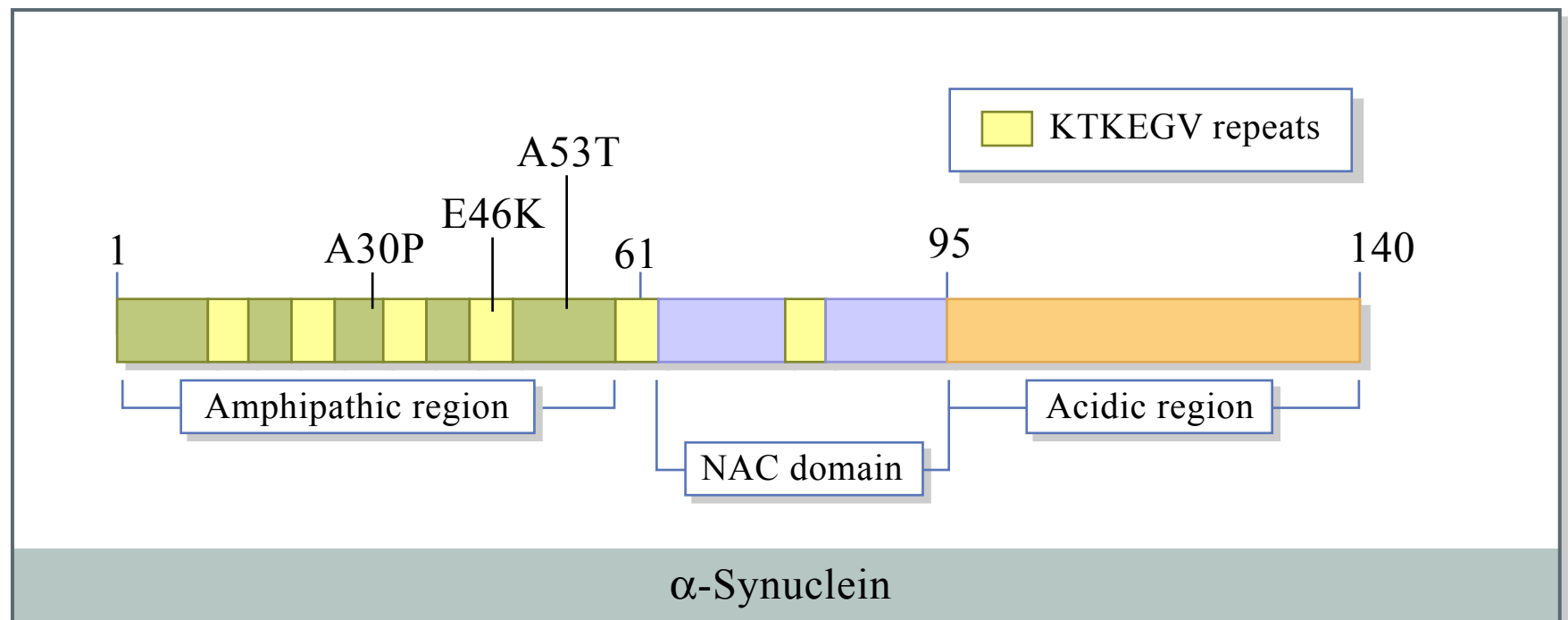

# Parkin (PARK2)

- First described in consanguineous Japanese families with autosomal recessive juvenile parkinsonism (ARJP), in 1997
- Most common known cause of early-onset PD; homozygous parkin mutations found in 49% of familial early-onset PD and 18% sporadic early-onset PD in European populations (early-onset < 45 years)
- Parkin mutations rare in late-onset PD (> 50 years)
- Asymptomatic heterozygous carriers show non-progressive decreased F-DOPA uptake; adaptation or predisposition?
- Parkin gene is the second-largest known (1.3 Mb with 12 exons); protein consists of 465 AA
- Wild-type protein is thought to be part of the ubiquitin-proteasome system (UPS) as an E3-ligase; tags proteins for degradation
- clinical phenotype (divergent from sporadic PD): symmetrical progression, dystonia, hyperreflexia, slow disease progression, L-DOPA responsive; dementia is rare
- neuropathology: selective cell loss in nigrostriatal pathway and locus ceruleus, absence of Lewy bodies (compound heterozygous cases have shown LB and/or NFT)

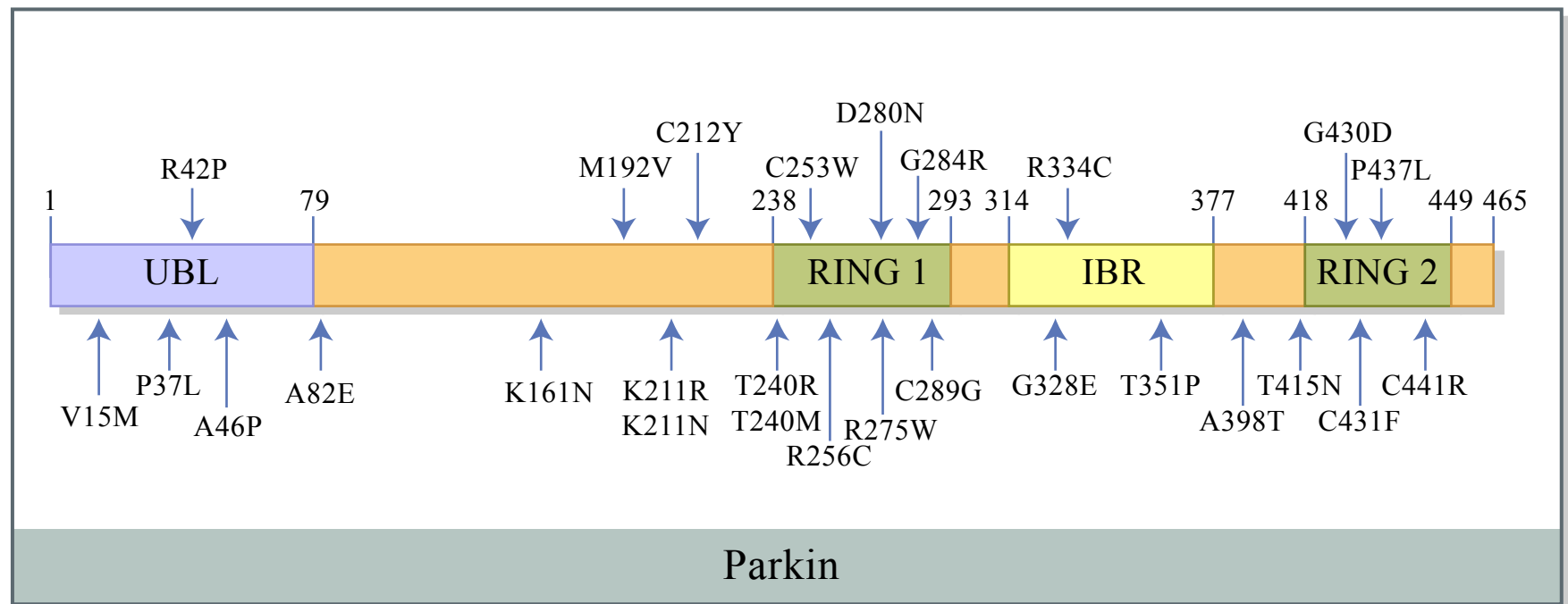
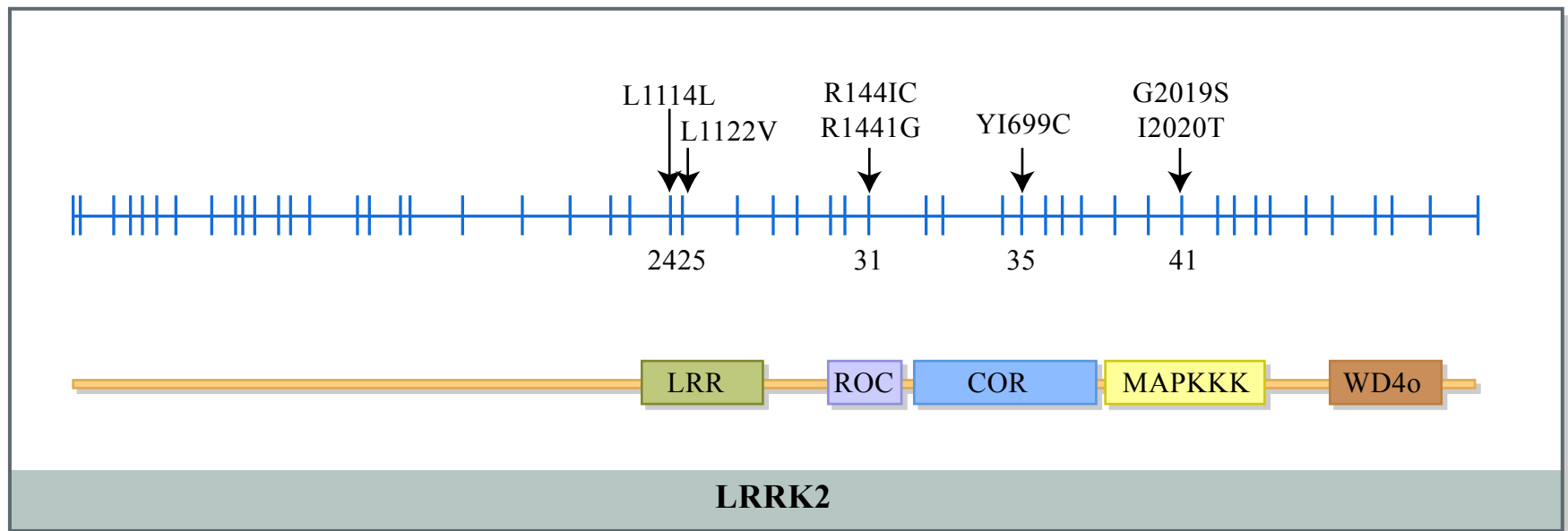

Figure by MIT OCW.

# LRRK2 (PARK8)

- First mapped in a large Japanese family with autosomal dominant inheritance; linkage was subsequently confirmed in several European families
- 2,572 AA protein; may be involved in multiple processes, including substrate binding, protein phosphorylation, and protein-protein interactions
- Gly2019Ser substitution is most common in Caucasians (0.5-2.0% sporadic and 5% familial parkinsonism; perhaps 18-30% for Ashkenazi Jews and North African Arab populations)
- penetrance is age-dependent, going from 17% at age 50 to 85% at age 70
- clinical phenotype is similar to typical late-onset PD; asymmetrical onset of symptoms, L-DOPA responsive, no indication of dementia or autonomic dysfunction above that of sporadic PD
- neuropathology is mixed: most cases show typical LBD, some show tau-positive pathology, while others show only nigral degeneration without LB or NFT
- Unclear how LRRK2 substitutions result in neuropathology; possibly a sensor of cellular stress and/or involved in the initiation of cellular apoptosis



# Other implicated genes

- DJ-1 (PARK7)
  - autosomal recessive
  - large deletions and missense mutations associated with early-onset PD
  - rare overall (accounts for < 1% of early-onset PD)
  - primarily localized to mitochondria; possibly a molecular chaperone induced by oxidative stress
  - no cases have come to autopsy
- PINK1 (PARK6)
  - compound heterozygote and homozygous mutations identified in 1-2% of early-onset PD
  - wild-type protein believed to protect against mitochondrial dysfunction and stress-induced apoptosis
  - prevalence of PINK1 in sporadic PD is higher than controls; risk factor?
  - no cases have come to autopsy
- UCH-L1 (PARK5)
  - wild-type UCH-L1 functions in UBS (recycles ubiquitin monomers)
  - UCH-L1-null mice show neurodegenerative changes, but not in the nigrostriatal pathway
  - UCH-L1 is a prominent component of Lewy bodies
  - found in two members of PD-affected family; further mutations have not been discovered despite extensive screening
- COMT-Val158Met polymorphism
  - metabolizes dopamine in neurons; associated with increased relative risk of PD

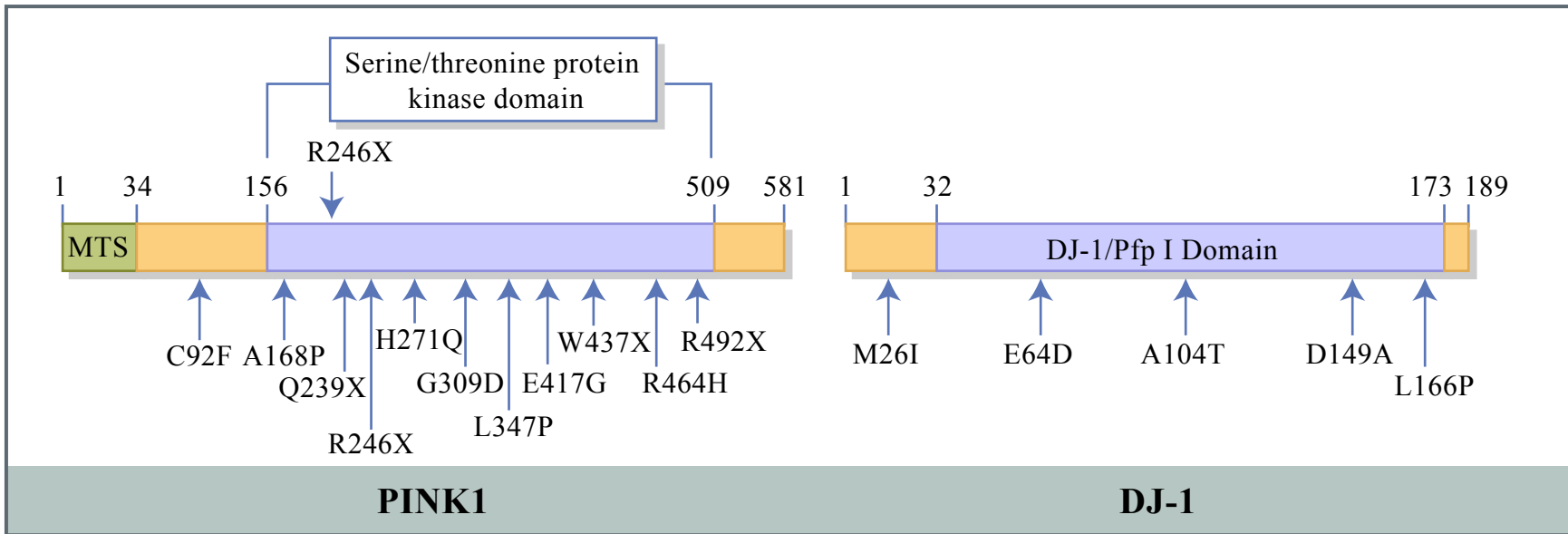

Figure by MIT OCW.

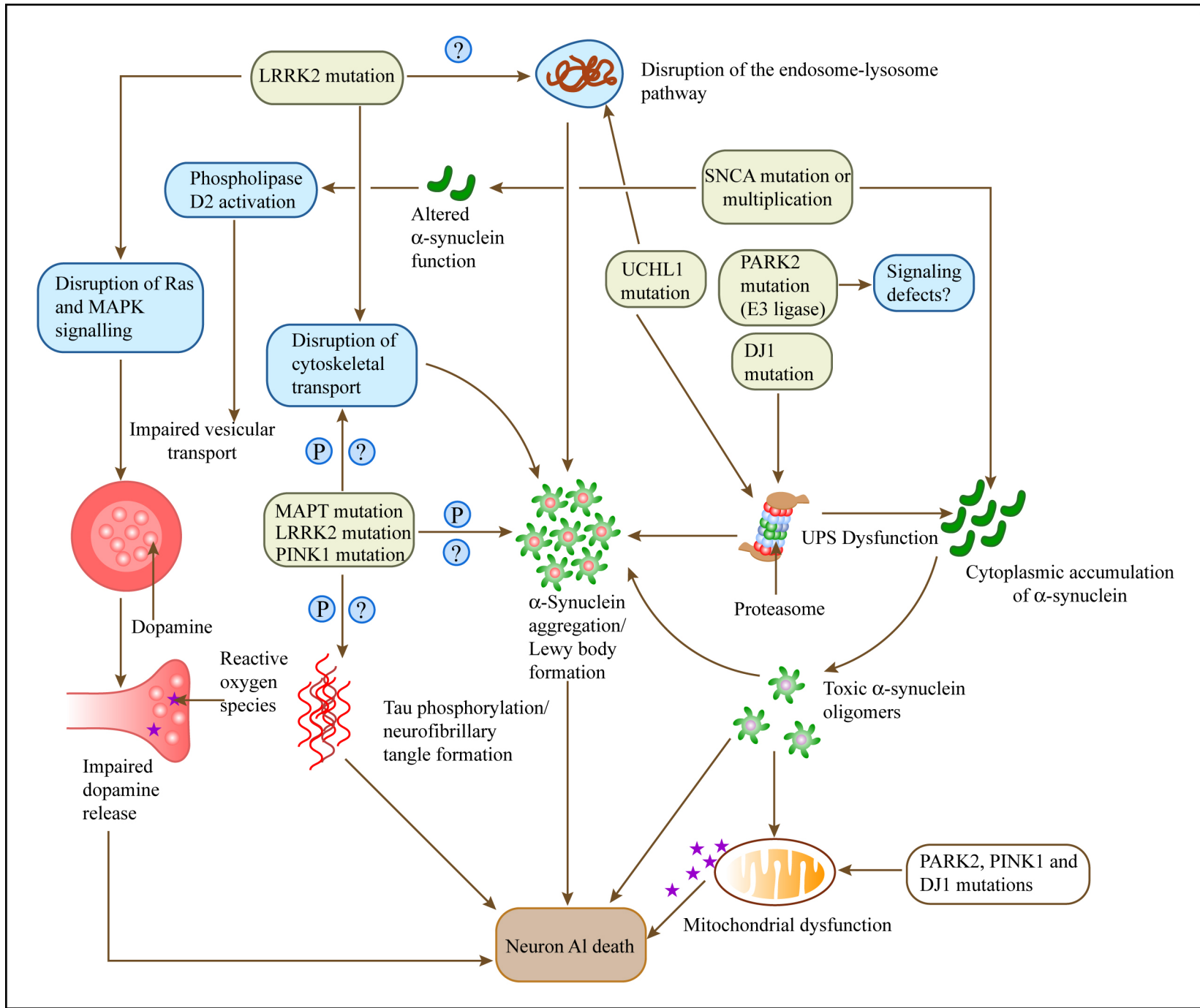
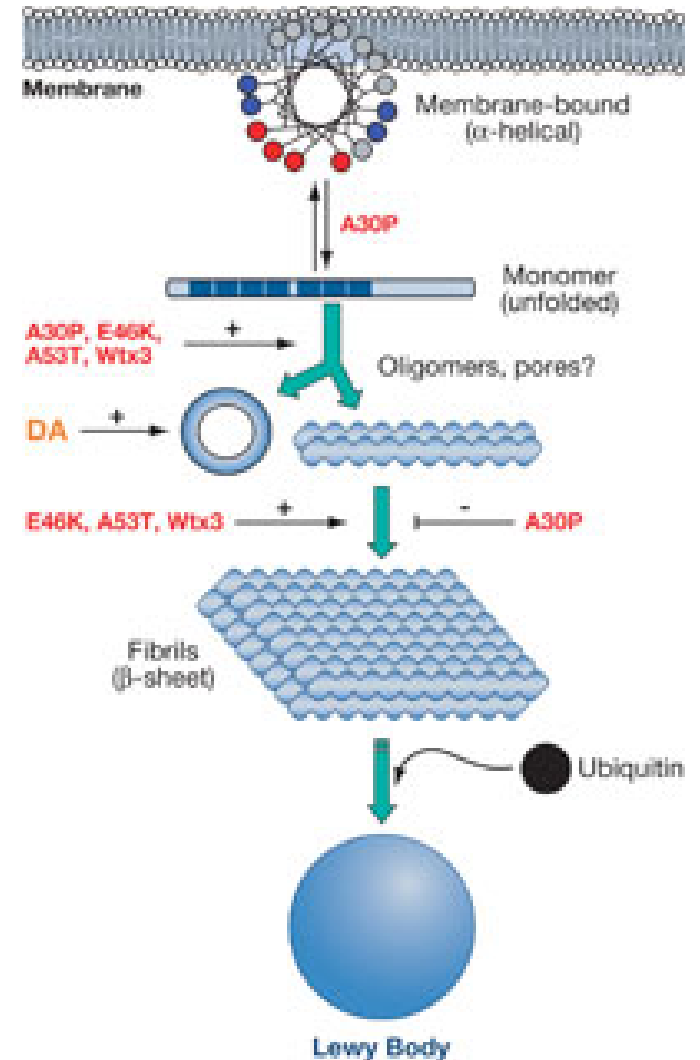

Figure by MIT OCW.

# $\alpha$ -synuclein aggregation

- wild-type  $\alpha$ -synuclein has an amphipathic association with plasma membrane, where it might mediate phospholipase D activity (implications in vesicular transport and exocytosis)
- membrane-bound and cytosolic  $\alpha$ -synuclein are normally in dynamic equilibrium
- cytosolic  $\alpha$ -synuclein binds to tyrosine hydroxylase (TH) and inhibits cellular dopamine production
- missense mutations may alter lipid-soluble properties of  $\alpha$ -synuclein, leading to increased cytosolic content and increased propensity for oligomerization
- duplications and triplications may increase cytosolic  $\alpha$ -synuclein levels and lead to aggregation
- aggregation also occurs in sporadic PD, however; other  $\alpha$ -synuclein modifications (alternative splicing, alterations in promoter regions, other interacting genes) may be involved



# Ubiquitin-proteasome system (UPS)

- UPS is a clearing system for misfolded or damaged proteins
- Ubiquitin monomers (Ub) are activated by E1 enzymes and transferred to E2 enzymes
- Ubiquitin protein ligase (E3) enzymes (such as parkin) mediate the transfer of ubiquitin to target proteins
- multiple transfers result in poly-ubiquitination; such proteins are targeted for degradation by the 26S proteasome
- poly-ubiquitin chains are recycled back into free Ub monomers by deubiquinating (DUB) enzymes (such as UCH-L1)
- Non-proteasomal functions of ubiquitination include DNA repair, endocytosis, protein trafficking, and transcription
- parkin (an E3 ligase) has an unusually high number of substrates, some cytotoxic
- lack of LB in parkin-associated disease may point to a protective function for  $\alpha$ -synuclein aggregation

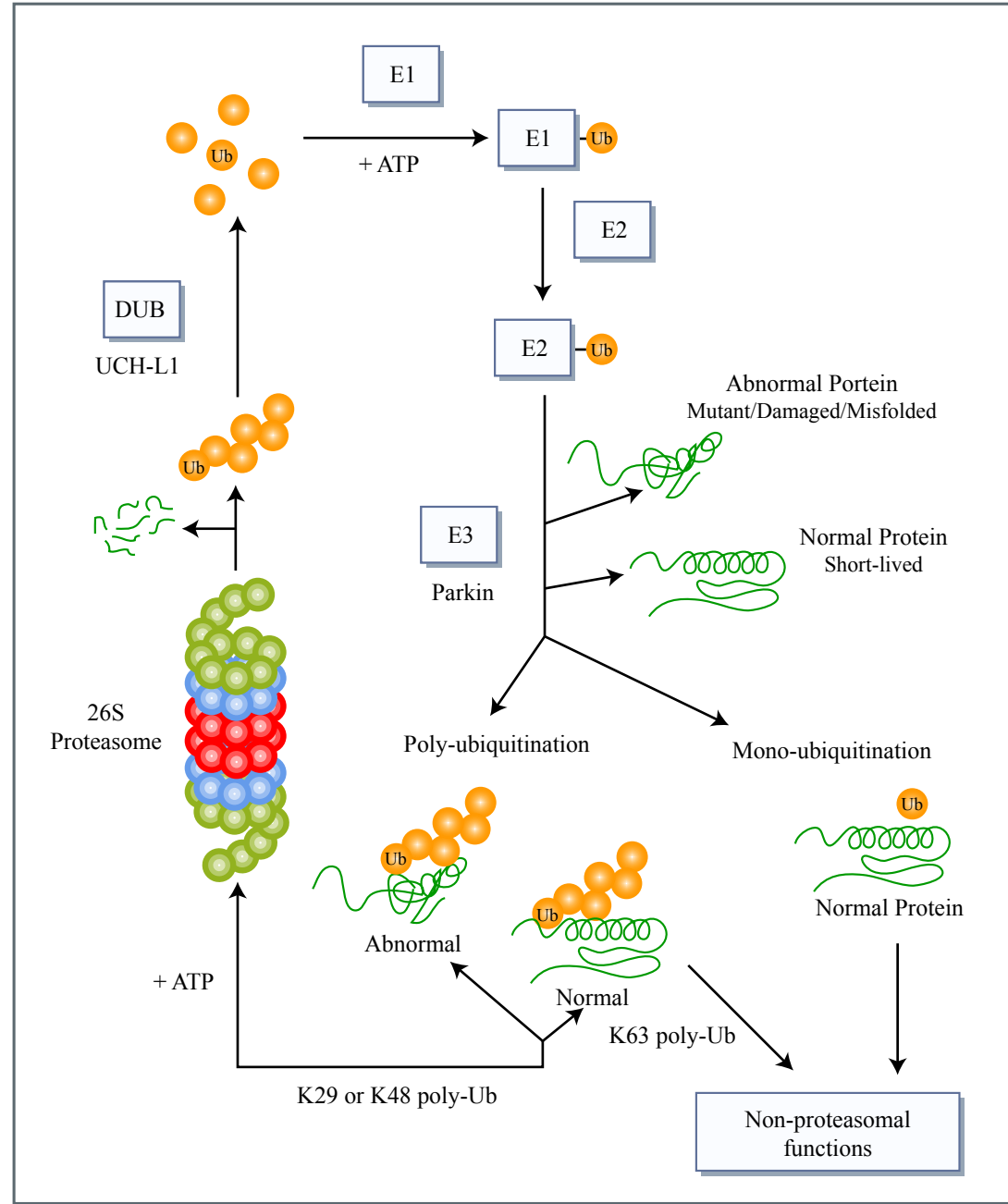



# Mitochondrial dysfunction / oxidative stress

- There is evidence for extensive oxidative damage and decreased mitochondrial (complex-I) activity in SNc of sporadic PD patients
- Oxidative stress may arise from mitochondrial dysfunction, dopamine production, increase in reactive iron, environmental toxins, or impaired antioxidant defense pathways
- MPTP, Paraquat, and rotenone are all complex-I inhibitors, and all induce parkinsonian-like symptoms
- Inhibition of complex-I activity, both in vivo and in vitro, consistently leads to aggregation of  $\alpha$ -synuclein inclusions, and  $\alpha$ -synuclein knockout mice are resistant to MPTP; UPS dysfunction and LB pathology may be a downstream consequence of mitochondrial dysfunction

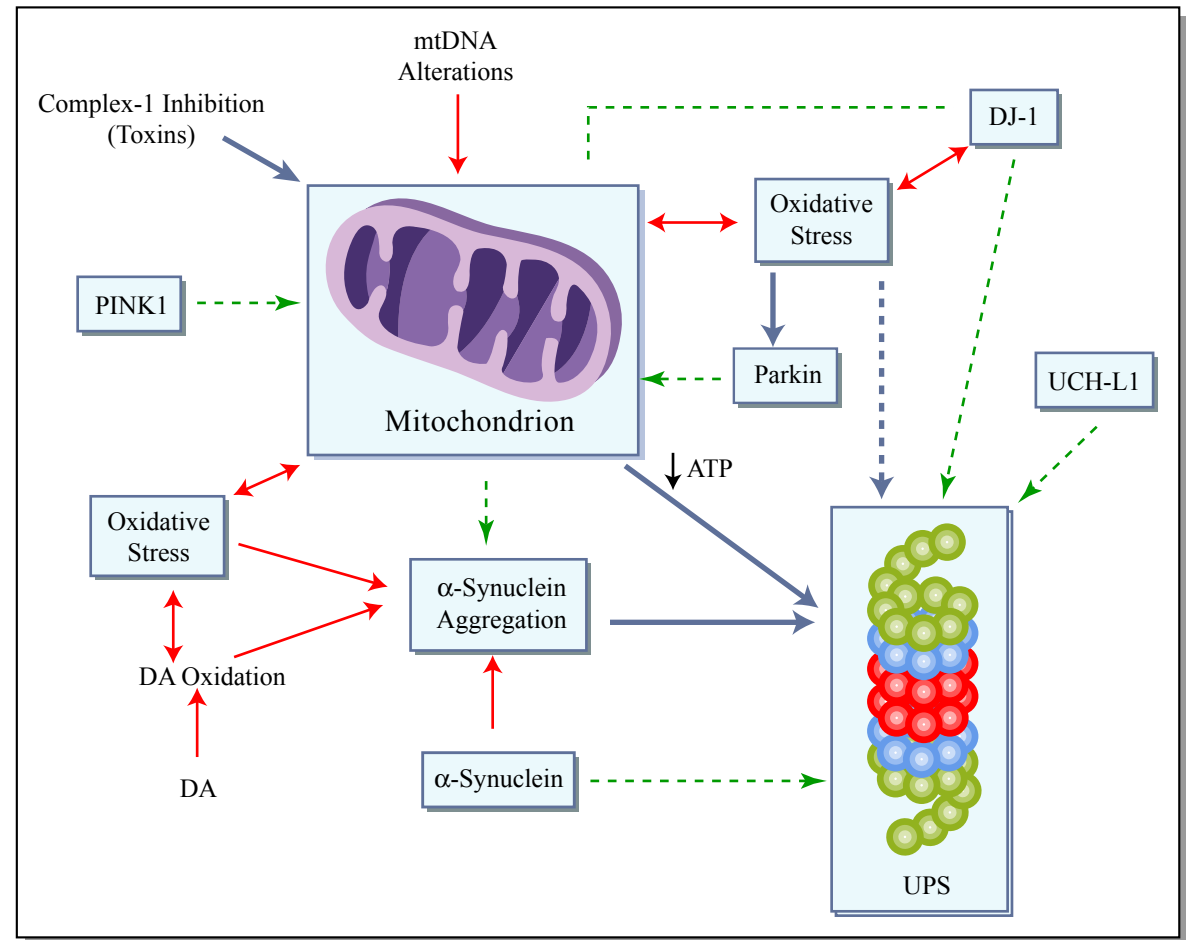

Moore et al., 2005

Figure by MIT OCW.

- DJ-1 and PINK1 probably play protective roles in mitochondrial function, the loss of which may predispose to sporadic PD

# Other factors...

- Pitx3, PKC $\gamma$ , ATM, TFG $\alpha$ , DRD2, Girk2, Ceruloplasmin, COX2 - roles found in transcription factors, DNA repair, neurotrophic factors, iron detoxifiers, neuronal inflammation, synaptic receptors, mitochondrial genes - it's a rich tapestry.