



# Altimetry

- **Standard Atmosphere Referenced**
  - 29.92 inches of Hg
  - 3014 mb
- **Pressure Altitude**
  - Altitude of Pressure in Std Atmosphere
  - Used above reference Flight Level (FL180 in US)
- **Density Altitude**
  - Altitude of density in Std Atmosphere
  - Used for performance (TO)
- **Barometric Altitude**
  - Estimated altitude corrected for surface pressure
  - MSL Altitude above Mean Sea Level (QNH)
  - AGL Altitude above Ground Level (QFE)
- **Radar Altitude (Cat II and III Approaches)**
  - 5 cm radar - normally only below 3000ft (Terrain Noise)
- **Cabin Altitude (Pressurization)**



# Airspeed

- **Pneumatic Measurement based on Dynamic Pressure**
  - Pitot and Static
- **Indicated Airspeed**
  - Indicated on Instrument
  - Measurement of pressure on Aircraft (ie Load)
  - Used for structural operating limits
- **Calibrated Airspeed**
  - Pitot-Static Errors Calibrated out
  - Used for Flight Test and Performance
- **Groundspeed**
  - Achieved speed over ground
- **Mach Number**
  - Requires Static Air Temperature



# Air Data Sensors

- **Pitot Tube**
  - Heated for De-Ice
- **Static Port**
  - Location Sensitive
  - Typically 1/3 Back on Fuselage on Conventional aircraft
  - Bilateral with crosstie to avoid Side Slip Errors
  - Water Drain
- **Alpha Vane**
  - Heated for De-Ice
- **TAT Probe**
  - Inertial Separator for Water
  - Heated for De-Ice



# Temperature

- **Static Air Temperature**
- **Ram Rise**
- **Total Air Temperature**



# Integrated Air Data Systems

- **Air Data Computer**
  - Compensates out Static System Errors
  - Citation Example
- **Air Data Heading and Reference Systems (ADHARS)**



# Heading

- **Magnetic Compass**
  - Variation (Magnetic Deviation)
  - Deviation (Magnetic materials)
    - ◆ DC9 Example
  - Compass Card (Calibrated with Radios and Equip on)
- **Flux Gate Compass**
  - Electronic Magnetic Compass
    - ◆ Normally in Tail for deviation
- **Gyro Compass**
  - Precession
  - Slaved Flux Gate
- **Turn Coordinator**
  - (Rate Gyro)



# Inertial Reference Unit

- **Integrate acceleration from known position and velocity**
  - Velocity
  - Position
- **Need Heading**
  - Gyros
    - ◆ Mechanical
    - ◆ Laser
- **Can get Attitude**
  - Artificial Horizon (PFD. HUD)
- **Drift Errors**
  - IRU unusable in vertical direction (need baro alt)
  - Inflight Correction
    - ◆ DME
    - ◆ GPS
    - ◆ Star Sighting for Space Vehicles
- **Measurement Give Attitude Also**
- **777 Analytical Redundancy**



# Communications

- **Requirements**

- Communicate necessary information between formation elements and command node (LAN and Air-Ground)
- Bandwidth
- Low-Observable?
- Synchronous vs asynchronous

- **Constraints**

- Spectrum
- Antenna Location

- **Technologies**

- Radio
  - ◆ UHF, VHF, MMW
- Optical
  - ◆ Laser
- Protocols





# COMMUNICATION

- **Voice**
  - VHF (line of sight)
    - ◆ 118.0-135.0 Mhz
    - ◆ .025 spacing in US, 0.083 spacing in Europe)
  - UHF
    - ◆ 230-400 Mhz (guess)
  - HF (over the horizon)
  - Optical (secure)
- **Datalink**
  - ACARS (VHF) - VDL Mode 2
  - VDL Modes 3 and 4 (split voice and data)
  - HF Datalink (China and Selcal)
- **Geosynchronous (Inmarsatt)**
  - ◆ Antenna Requirements
- **LEO and MEO Networks**
- **Software Radios**
- **Antenna Requirements**



# Bandwidth Growth Trend

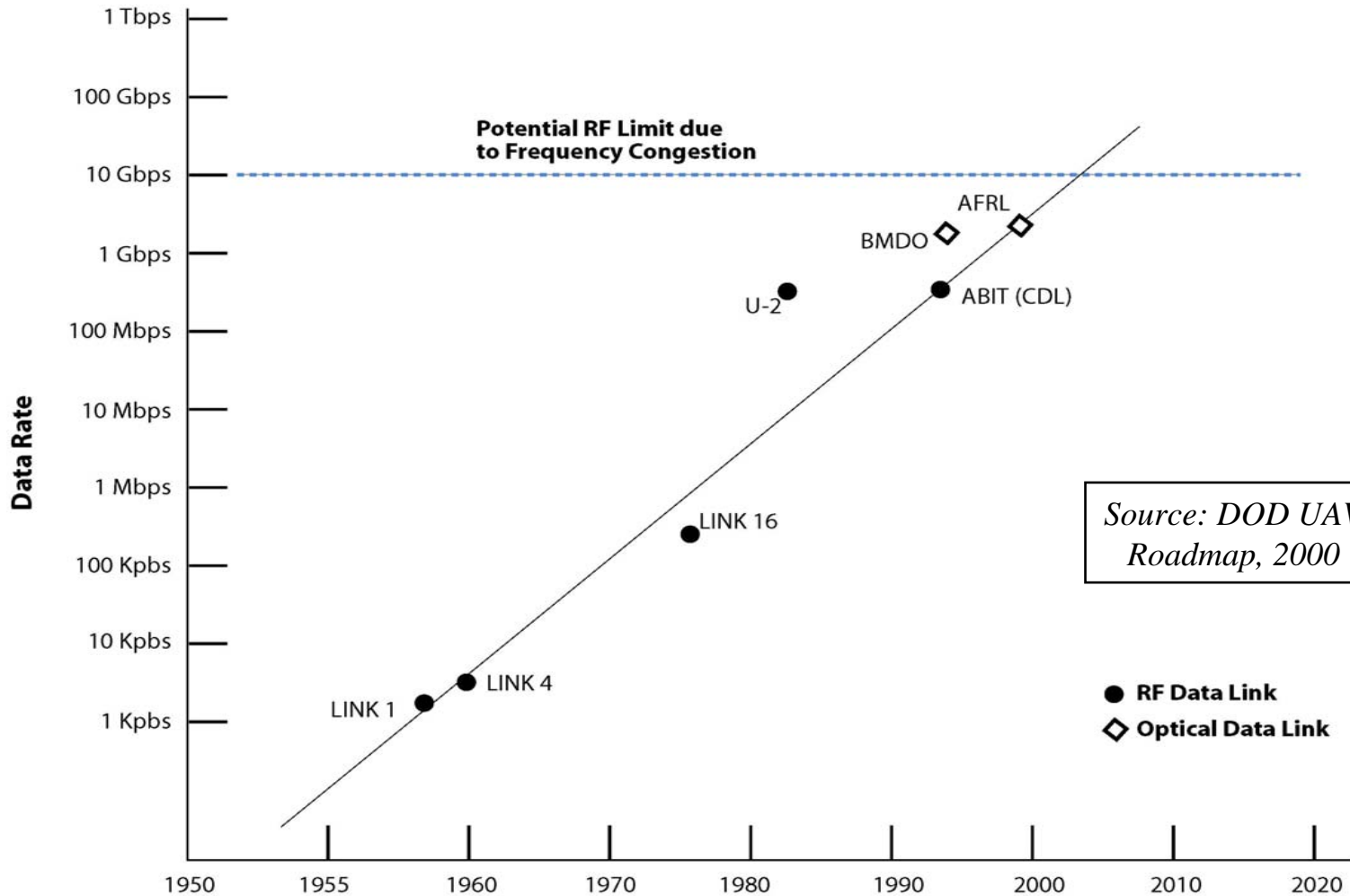



# Navigation

(relates to Surveillance)

- **Requirements**

- General Navigation (medium precision)
- Station Keeping (high precision)
- Integrity
- Availability

- **Constraints**

- Existing nav systems
- Loss of signal

- **Technologies**

- GPS/Galileo (need Differential)
  - ◆ Code vs Carrier Phase Approaches
- IRS/GPS
- Sensor Based Approaches for Station Keeping
  - ◆ Image (Visible, IR)
  - ◆ Range Finders (Laser, Ultrasonic)



# NAVIGATION (ENROUTE)

- **Radionavigation beacon**
  - VHF Omnidirectional Range (VOR)
  - Non-Directional Beacon (NDB)
  - Distance Measuring Equipment (DME)
  - TACAN
- **Area navigation systems (ground based)**
  - Omega
  - LORAN
- **Inertial navigation systems**
- **Satellite navigation systems**
  - GPS (CA)
  - GNSS (Galileo?)

# GPS

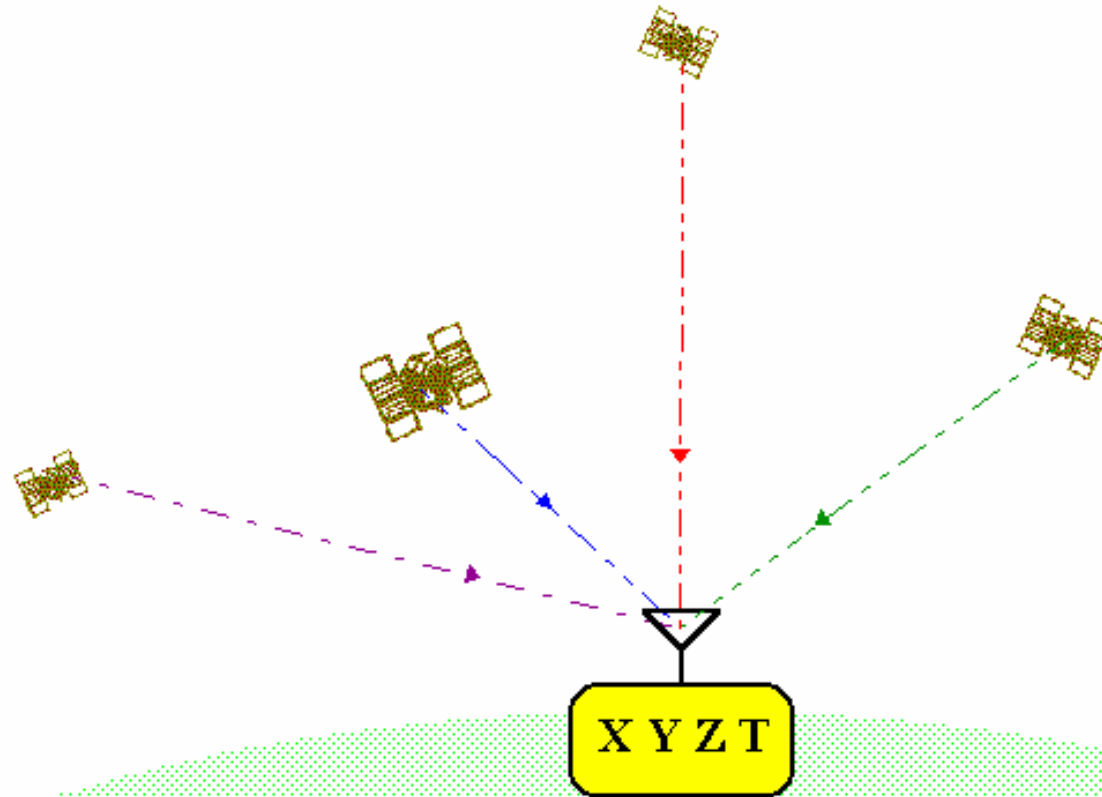

## The Global Positioning System

Measurements of code-phase arrival times from at least four satellites are used to estimate four quantities: position in three dimensions (X, Y, Z) and GPS time (T).

(Courtesy of Peter Dana. Used with permission.)

P. H. Dana 5/10/98

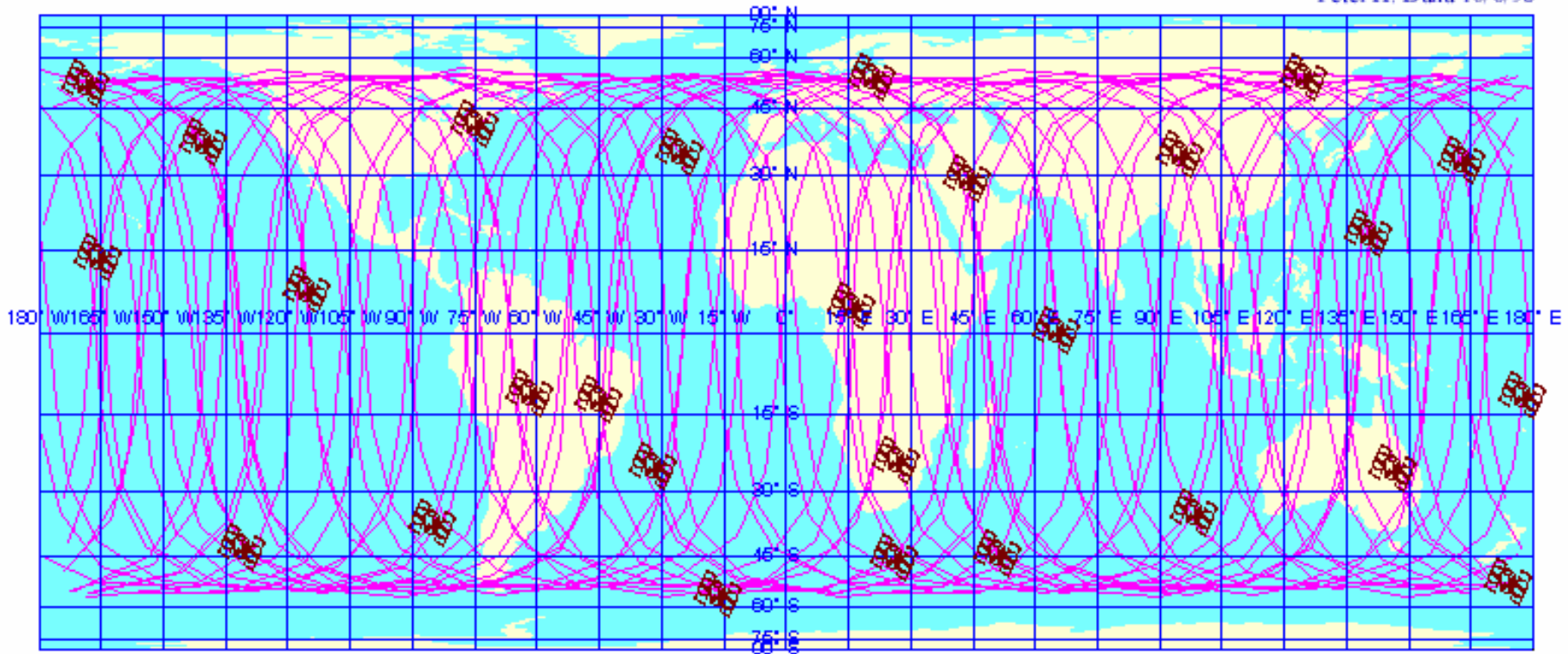

Global Positioning System Satellites and Orbits  
for 27 Operational Satellites on September 29, 1998

Satellite Positions at 00:00:00 9/29/98 with 24 hours (2 orbits) of Ground Tracks to 00:00:00 9/30/98



# GPS ISSUES

- **Requirements**
  - Accuracy
  - Integrity
  - Availability
- **Selective Availability (SA)**
  - Degraded to 100m accuracy
- **Control by US DoD**
  - International concerns
- **US guarantee of service free to world through 2005**
- **Vulnerability to jamming**
- **DGPS**
  - WAAS
  - EGNOS
  - LAAS



# NAVIGATION TRENDS (APPROACH)

- **Instrument Landing System (ILS)**
  - Cat. I (200 ft; 1/4 mile)
  - Cat. II (50 ft; 800 RVR)
  - Cat. III (0,0)
- **Microwave Landing System (MLS)**
- **GPS (100m)**
  - Wide Areas Augmentation System (5m)
    - ◆ LNAV-VNAV (250, 1/4 mile)
  - Local Area Augmentation System (0.1m)
    - ◆ Cat. III?
- **Change to Required Navigation Performance (RNP)**
  - RNP X
  - X is 95% lateral containment on NM



**JEPPESEN** 4 APR 97 (11-1)  
 \*ATIS **118.85**  
 \*AMARILLO Approach (R) **119.5**  
 ALBUQUERQUE Center (R) **127.85** when App inop.  
 \*AMARILLO Tower CTAF **118.3**  
 \*Ground **121.9**

**AMARILLO, TEXAS**  
 AMARILLO INTL  
 ILS Rwy 4  
 LOC **110.3 IAMA**  
 AISA  
 AM LOM  
 Apt. Elev **3605'**

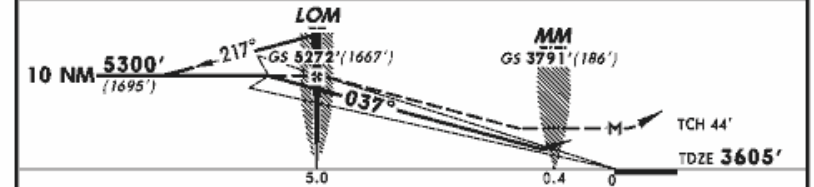
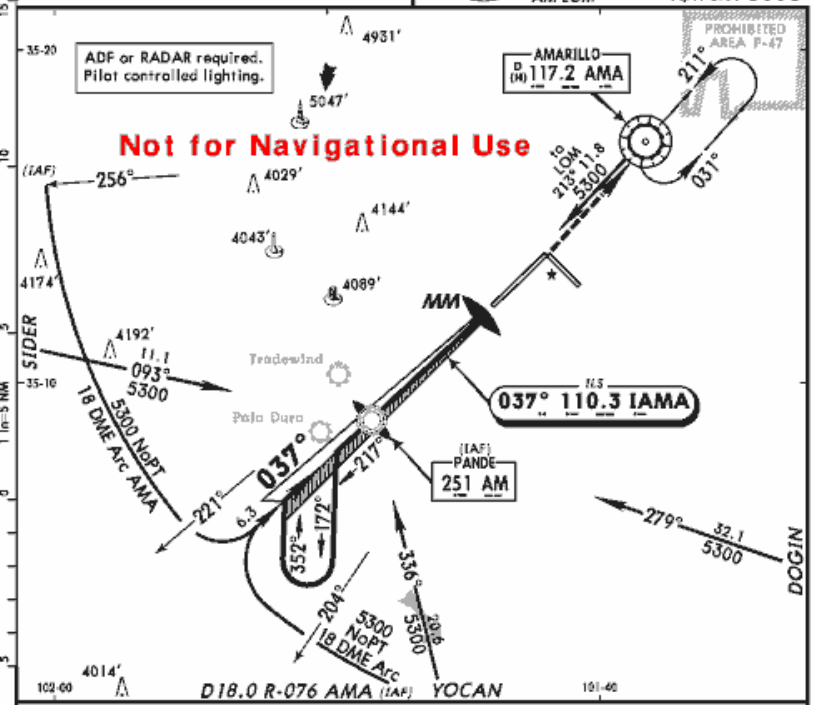
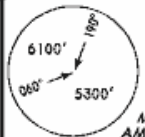

**MISSED APPROACH:** Climb to **5000'** direct **AMA VOR** and hold.

	STRAIGHT-IN LANDING RWY 4				CIRCLE-TO-LAND	
	ILS DA(H) <b>3805'</b> (200')		LOC (GS out) MDA(H) <b>4000'</b> (395')		Min Kts	MDA(H)
A	FULL		RAIL out		90	<b>4100'</b> (495') - 1
B	3/4		1		120	<b>4100'</b> (495') - 1
C	3/4		1 1/4		140	<b>4100'</b> (495') - 1 1/2
D	3/4		1 1/4		165	<b>4240'</b> (635') - 2
<b>Gnd speed-Kts</b>						
GS	3.00*	377	485	539	647	755
LOM to MAP	5.0	4:17	3:20	3:00	2:30	2:09

CHANGES: Minimums. © JEPPESEN SANDERSON, INC., 1987, 1997. ALL RIGHTS RESERVED.

# NAVIGATION TRENDS (APPROACH)

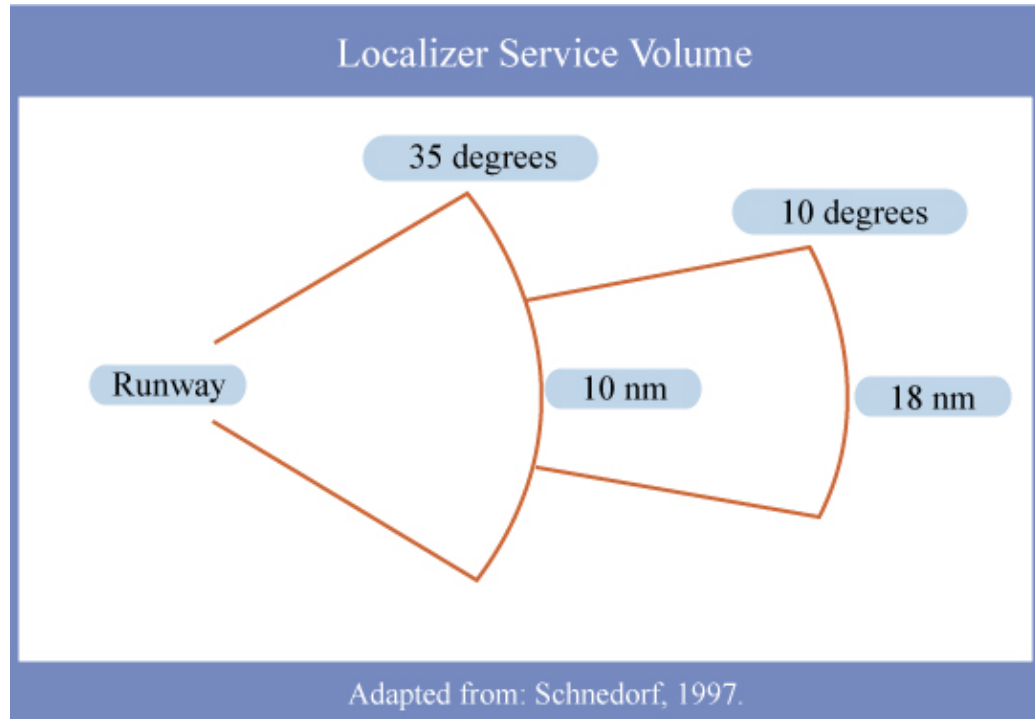

# FAA Instrument Landing Systems

## VHF LOCALIZER

### Provide Horizontal Guidance

108.10 to 111.95 MHz radiates about 100 watts horizontal polarization. Modulation frequencies 90 to 150 Hz. Modulation depth on course 20% for each frequency. Code identification (1020 Hz, 5%) and voice communication (modulated 50%) provided on same channel.

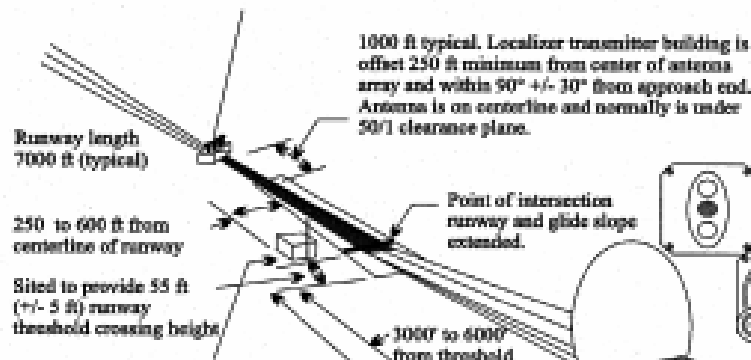

## VHF GLIDE SLOPE TRANSMITTER

### Provides Vertical Guidance

329.3 to 335.0 MHz. Radiated about 5 watts. Horizontal polarization, modulation on path 40% for 90 Hz and 150 Hz. The standard glide slope angle is 3.0 degrees. It may be higher depending on local terrain.

**RATE OF DESCENT CHART**  
(feet per minute)

Speed (Knots)	Angle		
	2.5°	2.75°	3°
90	400	440	475
110	485	535	585
130	575	630	690
150	665	730	795
160	707	778	849

Compass locators, rated at 25 watts output 190 to 535 KHz, are installed at many outer and some middle markers. A 400 Hz or a 1020 Hz tone, modulating the carrier about 95%, is keyed with the first two letters of the ILS identification on the outer locator and the last two letters on the middle locator. At some locations, simultaneous voice transmissions from the control tower are provided, with appropriate reduction in identification percentage.

## ILS

### (FAA INSTRUMENT LANDING SYSTEMS)

### STANDARD CHARACTERISTICS AND TERMINOLOGY

ILS approach charts should be consulted to obtain variations of individual systems.

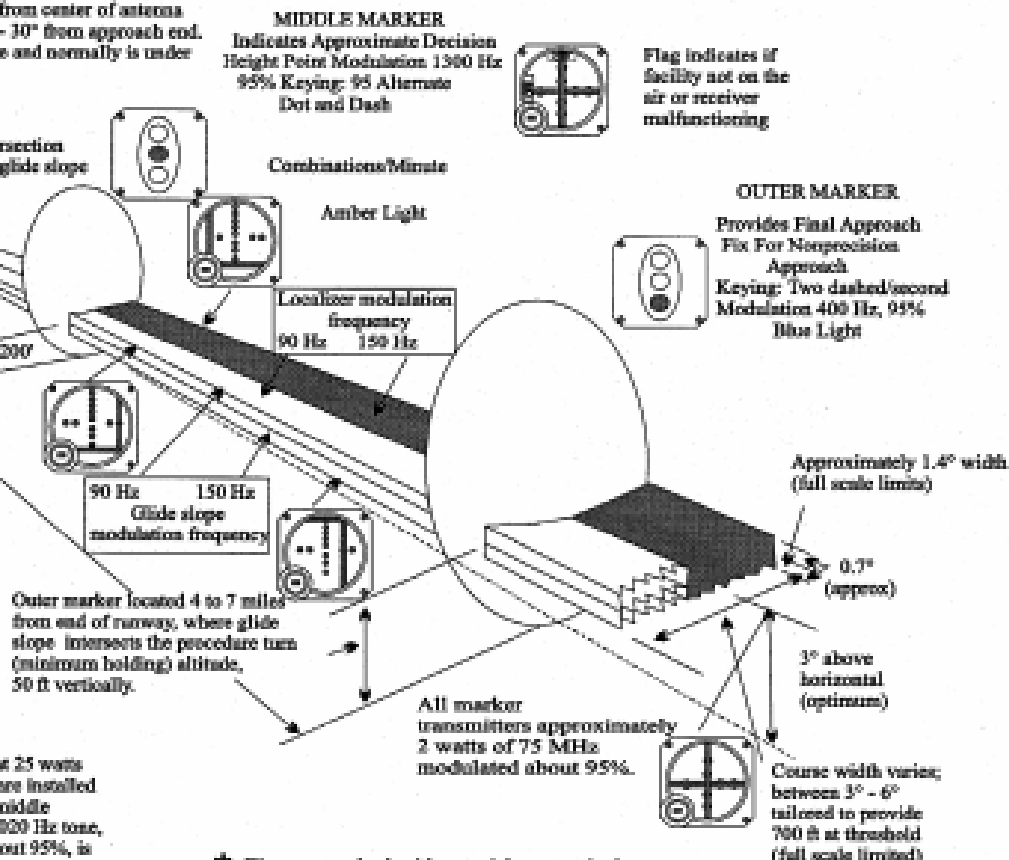

★ Figures marked with asterisk are typical. Actual figures vary with deviations in distances to markers, glide angles and localizer widths.



# GPS Approach Navigation

- **Requirements**

- Accuracy (RNP)
- Availability
- Integrity

- **Differential GPS**

- Wide Area Augmentation System (WAAS)
- Local Area Augmentation System (LAAS)



# Surveillance

- **Requirements**

- Observed states of lead elements sufficient to form-up and maintain
- Feed forward states (intent)

- **Constraints**

- Sight Angles
- Installation (weight, cost, power, etc)
- Cooperative Targets

- **Technologies**

- Automatic Dependant Surveillance Broadcast (ADS-B)
- Image Based Systems (Vis, IR)
- Radar (X Band, MMW0)
- Range Finders (Laser)
- Sensor Fusion Systems



# RADAR

- **Weather Radar (10 CM)**
- **Search and Track**
  - Doppler
- **Synthetic Aperture Radar**
- **Radar Altimeter**



# RADAR

- **Wavelength  $\lambda$** 
  - S Band (10 cm)
  - X Band (3 cm)
  - Ku Band (1 cm)
  - Millimeter Wave (94 Ghz pass band)
- **Radar Range Equation**
- **Beamwidth  $\Theta$** 
  - $\Theta = \lambda/D$
  - D = Diameter of Circular Antenna
  - Pencil beam vs Fan Beam
- **Mechanically Steered Antennas**
  - Scan and Tilt



# Imaging and Night Vision Systems

- **Infrared**
  - Special Optics (eg Gallium Arsinide)
  - Water Contamination
  - Sensor Cooling Requirements
- **Image Intensifier Systems**
- **Pointing Systems**



# Datalink Based Systems

- **JTIDS**
- **Mode S Transponders**
  - Traffic Information Service
- **ADS-B**





# Self Reporting Aircraft States ADS-B



(Image removed due to copyright considerations.)

Bob Hilb  
UPS/Cargo Airline Association

# INTENT REPRESENTATION (consider other states)

- Intent formalized in “Surveillance State Vector”

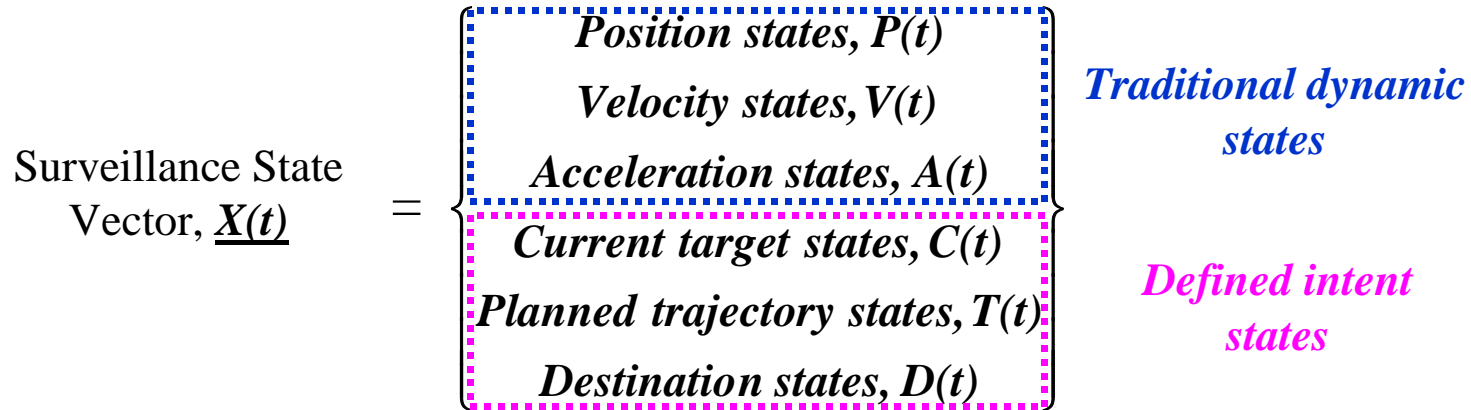

- Accurately mimics intent communication & execution in ATC

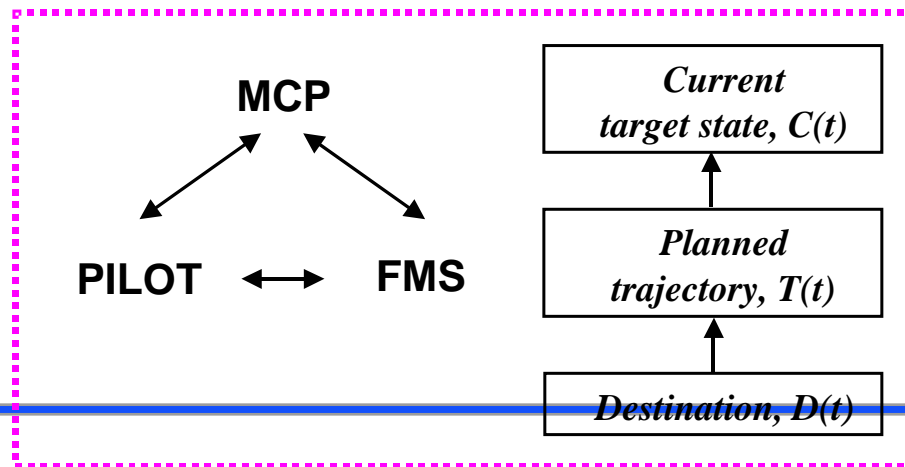

# ADS-B SURVEILLANCE ENVIRONMENT

- Potential access to more states (e.g. dynamic and intent)
- Need to assess benefits for conformance monitoring

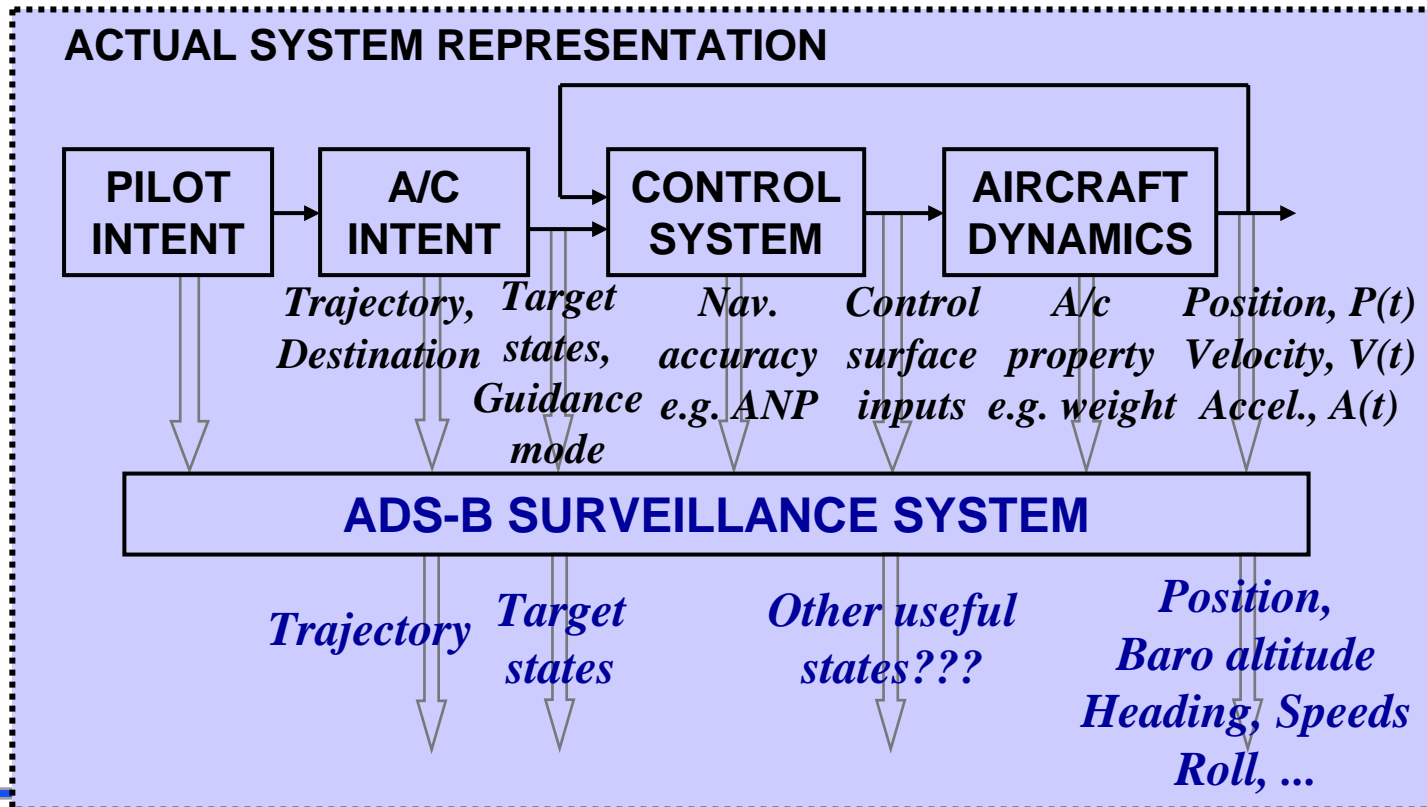



# Engine Instrumentation

- **Rotation Rates**
  - N1
- **Exhaust Pressure Ratio**
- **Temperatures**
  - Turbine Inlet Temperature
- **Oil Pressure**
- **Oil Temp**
- **Vibration**



# Warning Systems

- **Master Caution**
  - Fire
  - Low Pressure (eg oil)
  - ...
- **Stall Warning**
  - Stick Shaker
- **Traffic Collision Avoidance System (TCAS)**
- **Enhanced Ground Proximity Warning System (EGPWS)**
- **Envelope Protection**

# Envelope Protection

## Fly-by-wire protection - Normal Law

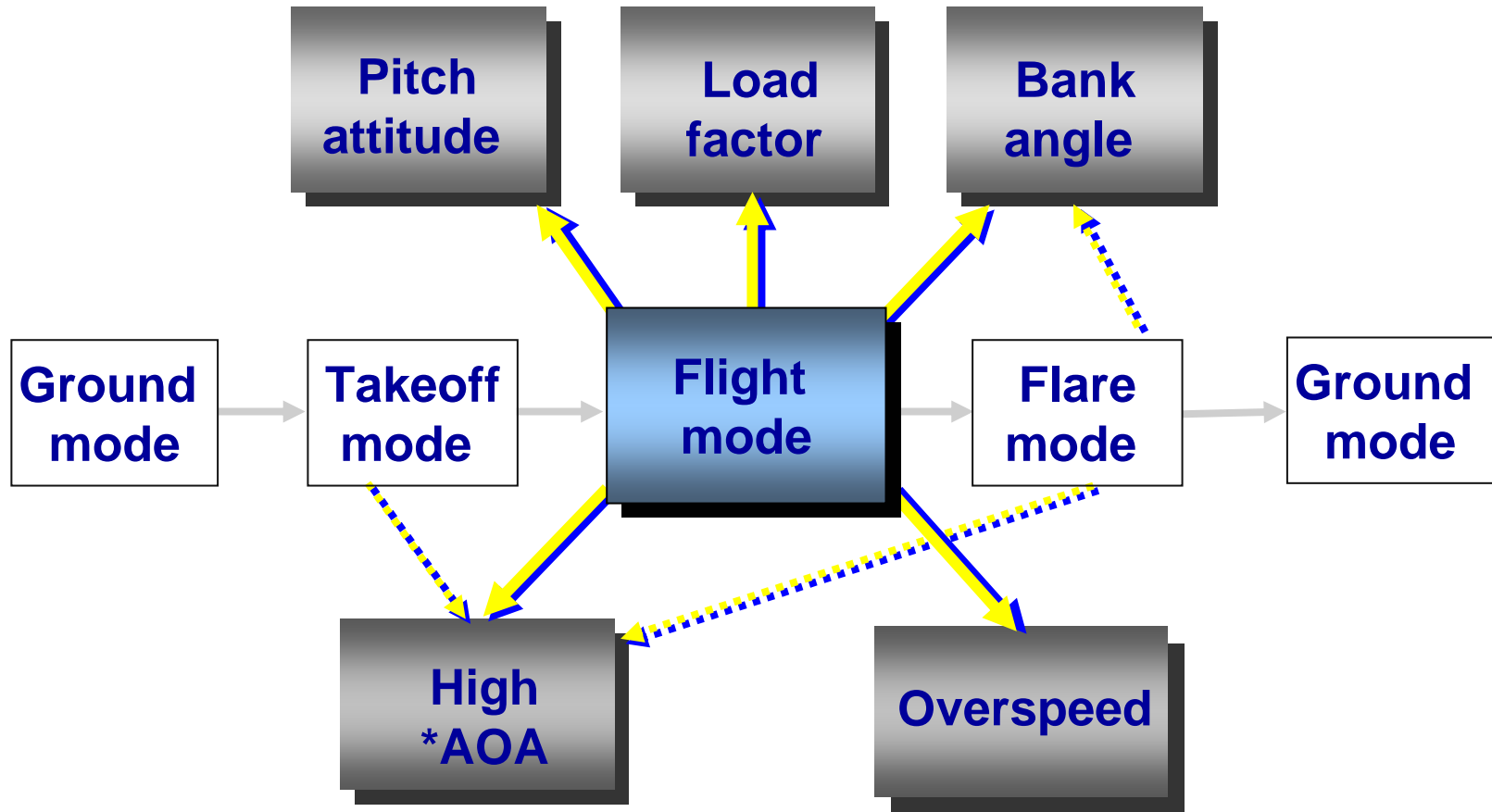

\* Angle of Attack (AOA)



# High Angle of Attack Protection

