

# Linear Systems of Equations. . . in a Nutshell

AT Patera, M Yano

November 19, 2014

Draft V1.3 ©MIT 2014. From *Math, Numerics, & Programming for Mechanical Engineers . . . in a Nutshell* by AT Patera and M Yano. All rights reserved.

## 1 Preamble

Linear mathematical models for equilibrium phenomena yield linear systems of equations. In some cases the model is “lumped” and thus discrete by construction, in other cases the model is continuous but then discrete by approximation. In either case we can ask the same questions: how can we form a system matrix which expresses the mathematical model in the language of linear algebra? how can we characterize the system matrix in terms of structure and mathematical properties? how can we determine if the linear systems of equations has a unique solution — and, if not, identify the cause of non-existence or non-uniqueness? In short, we consider those aspects of linear systems which are necessary precursors to numerical solution.

We consider a linear system of  $n$  equations in  $n$  unknowns: given an  $n \times n$  matrix  $A$  and an  $n \times 1$  vector  $f$ , we wish to find an  $n \times 1$  vector  $u$  such that  $Au = f$ . In this nutshell we shall address the following topics related to this system of equations:

We demonstrate the process by which we express a mathematical model in terms of the system matrix  $A$ , force vector  $f$ , and solution vector  $u$ : equations to rows; unknowns to columns. By way of illustration we consider systems of springs and masses connected in various topologies.

We introduce the notion of sparsity, discuss the prevalence and origin of sparsity in mathematical models of physical systems, and provide several examples of sparse matrices  $A$  arising in the analysis of simple mechanical systems.

We define the properties of Symmetric Positive-Definite (SPD) matrices, present a physical interpretation of “SPDicity” in terms of potential (elastic) energy, and provide several examples of SPD matrices  $A$  which arise in the analysis of simple mechanical systems.

We discuss the existence and uniqueness of solutions to the equation  $Au = f$  for  $n = 2$  equations in  $n = 2$  unknowns. We identify three cases:  $Au = f$  admits a unique solution;  $Au = f$  has an infinity of solutions;  $Au = f$  has no solution. We provide in each case geometric interpretations from both a row perspective and a column perspective.

We state the necessary and sufficient conditions under which  $Au = f$  admits a unique solution:  $A$  has  $n$  independent columns;  $A$  has  $n$  independent rows; the inverse of  $A$ ,  $A^{-1}$ , exists; the determinant of  $A$  is nonzero;  $A$  has no zero eigenvalues. We also emphasize an important sufficient condition:  $A$  is SPD.

We provide a detailed example — a system of two masses and two springs — for which we can understand the cause of non-existence and non-uniqueness, and the general form of non-unique solutions, in terms of deficiencies in the underlying mathematical model of our physical system.

We do not consider here computational methods for the solution of linear systems of equations.

Prerequisites: matrix and vector operations; “ $2 \times 2$ ” linear algebra: linear independence, the matrix inverse, eigenvalues and eigenvectors, the determinant; elementary mechanics: force balances, Hooke’s Law.

## 2 A Model Equilibrium Problem

### 2.1 Description

We will introduce here a simple system of springs and masses, shown in Figure 1, which will serve throughout this nutshell to illustrate various concepts associated with linear systems. Mass 1 has mass  $m_1$ ; Mass 1 is connected to a stationary wall by a spring with stiffness  $k_1$ , and to Mass 2 by a spring with stiffness  $k_2$ . Mass 2 has mass  $m_2$ ; Mass 2 is connected only to Mass 1 (by the spring with stiffness  $k_2$ ). We shall assume that  $k_1 \geq 0$  and  $k_2 \geq 0$ .

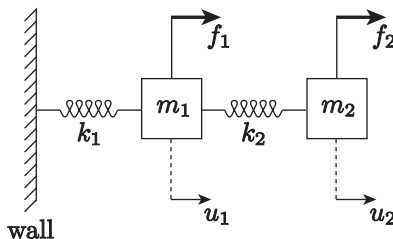

Figure 1: A system of two masses and two springs anchored to a single wall.

We denote the displacements of Mass 1 and Mass 2 by  $u_1$  and  $u_2$ , respectively: positive values correspond to displacement away from the wall; we choose our reference such that in the absence of applied forces — the springs unstretched —  $u_1 = u_2 = 0$ . We next introduce (steady) forces  $f_1$  and  $f_2$  on Mass 1 and Mass 2, respectively; positive values correspond to force away from the wall. We would like to find the equilibrium displacements of the two masses,  $u_1$  and  $u_2$ , for prescribed forces  $f_1$  and  $f_2$ .

We note that while all real systems are inherently dissipative and therefore are characterized not just by springs and masses but also dampers, the dampers (or damping coefficients) typically do not affect the system at equilibrium — since  $d/dt$  vanishes in the steady state — and hence for equilibrium considerations we may neglect losses. Of course, it is damping which ensures that the system ultimately achieves a stationary (time-independent) equilibrium.

We now derive the equations which must be satisfied by the displacements  $u_1$  and  $u_2$  at equilibrium. We first consider the forces on Mass 1, as shown in Figure 2. Note we apply here Hooke’s law — a constitutive relation — to relate the force in the spring to the compression or extension of the spring. In equilibrium the sum of the forces on Mass 1 — the applied forces and the forces due to the spring — must sum to zero, which yields

$$f_1 - k_1 u_1 + k_2(u_2 - u_1) = 0 .$$

(More generally, for a system *not* in equilibrium, the right-hand side would be  $m_1 \ddot{u}_1$  rather than

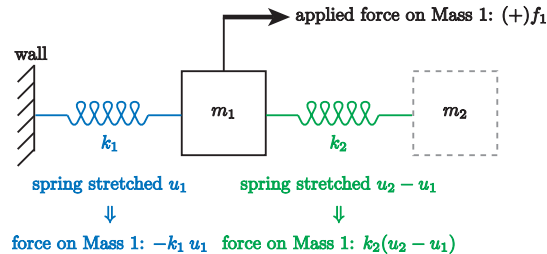

Figure 2: The forces on Mass 1.

zero.) A similar identification of the forces on Mass 2, shown in Figure 3, yields for force balance

$$f_2 - k_2(u_2 - u_1) = 0 .$$

This completes the physical statement of the problem.

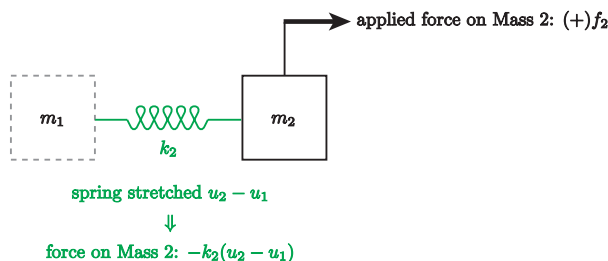

Figure 3: The forces on Mass 2.

Mathematically, our equations correspond to a system of  $n = 2$  linear equations, more precisely, 2 equations in 2 unknowns:

$$(k_1 + k_2) u_1 - k_2 u_2 = f_1 , \tag{1}$$

$$-k_2 u_1 + k_2 u_2 = f_2 . \tag{2}$$

Here  $u_1$  and  $u_2$  are *unknown*, and are placed on the left-hand side of the equations, and  $f_1$  and  $f_2$  are *known*, and placed on the right-hand side of the equations. In this nutshell we ask several questions about this linear system — and more generally about linear systems of  $n$  equations in  $n$  unknowns. First, existence: when do the equations have a solution? Second, uniqueness: if a solution exists, is it unique? Although these issues appear quite theoretical, in most cases the mathematical subtleties are in fact informed by physical (modeling) considerations.

To achieve these goals we must first express these equations in matrix form in order to best take advantage of both the theoretical and practical machinery of linear algebra. We write our two equations in two unknowns as  $Ku = f$ , where  $K$  is a  $2 \times 2$  matrix,  $u = (u_1 \ u_2)^T$  is a  $2 \times 1$  vector,

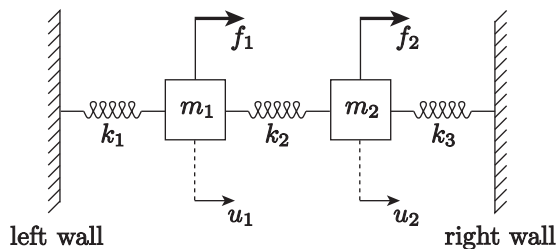

Figure 4: A system of two masses and three springs anchored to two walls. We shall assume that  $k_1 \geq 0$ ,  $k_2 \geq 0$ , and  $k_3 \geq 0$ .

and  $f = (f_1 \ f_2)^T$  is a  $2 \times 1$  vector. The elements of  $K$  are the coefficients of (1) and (2):

$$\begin{array}{ccc}
 & \text{unknown} & \text{known} \\
 \begin{pmatrix} k_1 + k_2 & -k_2 \\ -k_2 & k_2 \end{pmatrix} & \begin{pmatrix} u_1 \\ u_2 \end{pmatrix} & = \begin{pmatrix} f_1 \\ f_2 \end{pmatrix} \\
 \begin{array}{ccc} \leftarrow \text{Equation (1)} & & \leftarrow \text{Equation (2)} \\ K & u & f \\ 2 \times 2 & 2 \times 1 & 2 \times 1 \end{array} & & \end{array} \quad (3)$$

We briefly review the connection between equations (3) and (1)-(2). We first note that  $Ku = f$  implies equality of the two vectors  $Ku$  and  $f$  and hence equality of each component of  $Ku$  and  $f$ . The first component of the vector  $Ku$ , from the row interpretation of matrix multiplication,<sup>1</sup> is given by  $(k_1 + k_2)u_1 - k_2u_2$ ; the first component of the vector  $f$  is of course  $f_1$ . We thus conclude that  $(Ku)_1 = f_1$  correctly reproduces equation (1). A similar argument reveals that  $(Ku)_2 = f_2$  correctly reproduces equation (2). Here  $(Ku)_i, i = 1, 2$ , refers to the  $i^{\text{th}}$  element of the  $2 \times 1$  vector  $Ku$ .

**CYAWTP 1.** Consider the system of three springs and two masses shown in Figure 4. Provide the elements of the  $2 \times 2$  matrix  $K$ , expressed in terms of  $k_1, k_2$ , and  $k_3$ , such that the equilibrium displacement  $2 \times 1$  vector  $u$  satisfies  $Ku = f$ . Note here  $f = (f_1 \ f_2)^T$ .

## 2.2 SPD Property

A real  $n \times n$  matrix  $A$  is symmetric positive-definite (SPD) if and only if  $A$  is symmetric,

$$A^T = A, \quad (4)$$

and  $A$  is positive-definite,

$$v^T Av > 0 \text{ for any } n \times 1 \text{ vector } v \neq 0. \quad (5)$$

Note that  $Av$  is an  $n \times 1$  vector and hence  $v^T(Av)$  is a scalar — a real number. Note also that the positive-definite property (5) implies that if  $v^T Av = 0$  then  $v$  must be the zero vector. We emphasize that a matrix  $A$  must satisfy both conditions, (4) and (5), to qualify as SPD. There are many implications of the SPD property, all very pleasant.

<sup>1</sup>In many, but not all, cases it is more intuitive to develop matrix equations from the row interpretation of matrix multiplication; however, as we shall see, the column interpretation of matrix multiplication can be enlightening from the theoretical perspective.

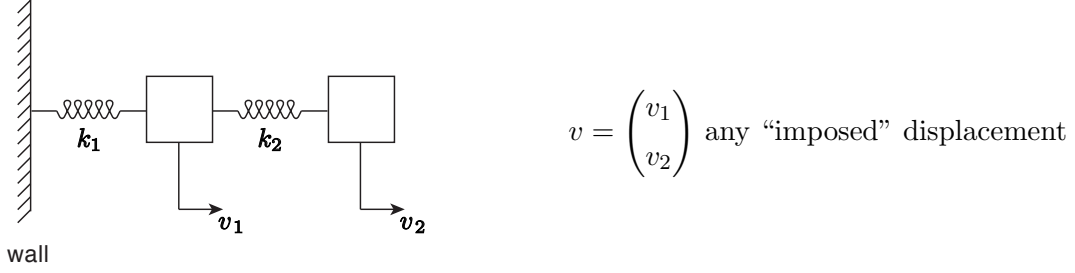

Figure 5: The system of springs and masses of Figure 1 subject to imposed displacement  $v$ .

We shall illustrate the SPD property for the  $2 \times 2$  matrix  $K$  associated with our simple spring system of (3). We shall further suppose here that our spring constants  $k_1$  and  $k_2$ , are strictly positive:

$$K \equiv \begin{pmatrix} k_1 + k_2 & -k_2 \\ -k_2 & k_2 \end{pmatrix} \text{ for } k_1 > 0, k_2 > 0 \quad . \quad (6)$$

We may now ask: does  $A \equiv K$  of (6) satisfy (4)-(5)? We can directly ascertain, from inspection, that  $K$  of (6) is symmetric:  $K - K^T = 0$ . It remains to determine if  $K$  of (6) is positive-definite.

Towards that end, we form the scalar  $v^T K v$  as

$$\begin{aligned} v^T K v &= (v_1 \quad v_2) \begin{pmatrix} k_1 + k_2 & -k_2 \\ -k_2 & k_2 \end{pmatrix} \begin{pmatrix} v_1 \\ v_2 \end{pmatrix} = (v_1 \quad v_2) \underbrace{\begin{pmatrix} (k_1 + k_2)v_1 - k_2 v_2 \\ -k_2 v_1 + k_2 v_2 \end{pmatrix}}_{Kv} \\ &= v_1^2(k_1 + k_2) - v_1 v_2 k_2 - v_2 v_1 k_2 + v_2^2 k_2 = v_1^2 k_1 + (v_1^2 - 2v_1 v_2 + v_2^2) k_2 \\ &= k_1 v_1^2 + k_2 (v_1 - v_2)^2 . \end{aligned} \quad (7)$$

We can immediately conclude, since  $k_1 > 0, k_2 > 0, v_1^2 \geq 0$ , and  $(v_2 - v_1)^2 \geq 0$ , that (a)  $v^T K v \geq 0$  for all  $v$ . It remains to demonstrate that  $v^T K v = 0$  only if  $v = 0$ . We first note that if  $v^T K v = 0$  then  $v_1 = 0$ :  $v^T K v = k_1 v_1^2 + k_2 (v_2 - v_1)^2 \geq k_1 v_1^2$  (since  $k_2 > 0$  and  $(v_2 - v_1)^2 \geq 0$ )  $> 0$  unless  $v_1 = 0$  (since  $k_1 > 0$ ). Similarly, we note that if  $v^T K v = 0$  then  $v_2 - v_1 = 0$ :  $v^T K v = k_1 v_1^2 + k_2 (v_2 - v_1)^2 \geq k_2 (v_2 - v_1)^2$  (since  $k_1 > 0$  and  $v_1^2 \geq 0$ )  $> 0$  unless  $v_2 = v_1$  (since  $k_2 > 0$ ). Thus  $v^T K v = 0$  implies  $v_1 = 0$  and  $v_2 - v_1 = 0$  and hence  $v_1 = v_2 = 0$ , which we may summarize as (b)  $v^T K v = 0$  only if  $v = (v_1 \quad v_2)^T = 0$ . We conclude from (a) and (b) that  $K$  of (6) is SPD:  $v^T K v > 0$  for all  $v \neq 0$ .

We can readily identify a connection between the SPD property of the “stiffness” matrix  $K$ , (6), and the energy of the associated physical system (depicted in Figure 1). We first introduce an arbitrary imposed displacement vector,  $v = (v_1 \quad v_2)^T$ , on our springs, as depicted in Figure 5. We next note that the potential energy in our spring system associated with this displacement  $v$  is given by

$$\text{PE (potential, or elastic, energy)} \equiv \underbrace{\frac{1}{2} k_1 v_1^2}_{\text{energy in Spring 1}} + \underbrace{\frac{1}{2} k_2 (v_2 - v_1)^2}_{\text{energy in Spring 2}} = \frac{1}{2} v^T K v ;$$

the last equality follows from (7). For positive spring constants we know that any stretching of either spring will result in positive potential energy: a physical “proof” that  $K$  of (6) is positive-definite.

**CYAWTP 2.** Consider again the matrix  $K$  of (3) but now for  $k_1 > 0$  and  $k_2 = 0$ . Show that  $K$  is not SPD (note to prove that a matrix  $A$  is *not* positive-definite, you need find only one example of a nonzero  $v$  for which  $v^T Av \leq 0$ ). Identify a displacement  $v$  for which  $v^T K v = 0$ , and interpret your result in terms of potential energy.

**CYAWTP 3.** Consider the matrix  $K$  of **CYAWTP 1** for  $k_1 > 0, k_2 > 0$ , and  $k_3 > 0$ . Demonstrate that  $K$  is SPD. Express the potential energy in the springs for an imposed displacement  $2 \times 1$  vector  $v$  in terms of  $K$  and  $v$ .

**CYAWTP 4.** Consider the four matrices

$$A^{(1)} \equiv \begin{pmatrix} 2 & -1 \\ -1 & -1 \end{pmatrix}, \quad A^{(2)} \equiv \begin{pmatrix} 2 & -1 \\ 1 & 1 \end{pmatrix}, \quad A^{(3)} \equiv \begin{pmatrix} 1 & -9 \\ -9 & 1 \end{pmatrix}, \quad A^{(4)} \equiv \begin{pmatrix} 10 & -9 \\ -9 & 9 \end{pmatrix}.$$

In each of these four cases, is the matrix symmetric? symmetric positive-definite (SPD)?

Finally, we close this discussion with a connection to eigenvalues: if a matrix  $A$  is symmetric then  $A$  has all *real* eigenvalues; a symmetric matrix  $A$  is furthermore positive-definite, hence SPD, if and only if  $A$  has all (real) *positive* eigenvalues. This provides another test for SPDicity: a matrix  $A$  is SPD if and only if  $A$  is symmetric,  $A^T = A$ , and all the eigenvalues of  $A$  are positive.

### 3 Existence and Uniqueness: $n = 2$

#### 3.1 Problem Statement

We shall now consider the existence and uniqueness of solutions to a general system of ( $n =$ ) 2 equations in ( $n =$ ) 2 unknowns. We first introduce a matrix  $A$  and vector  $f$  as

$$\begin{aligned} 2 \times 2 \text{ matrix } A &= \begin{pmatrix} A_{11} & A_{12} \\ A_{21} & A_{22} \end{pmatrix} ; \\ 2 \times 1 \text{ vector } f &= \begin{pmatrix} f_1 \\ f_2 \end{pmatrix} \end{aligned}$$

our equation for the  $2 \times 1$  unknown vector  $u$  can then be written as

$$Au = f, \quad \text{or} \quad \left. \begin{aligned} \begin{pmatrix} A_{11} & A_{12} \\ A_{21} & A_{22} \end{pmatrix} \begin{pmatrix} u_1 \\ u_2 \end{pmatrix} &= \begin{pmatrix} f_1 \\ f_2 \end{pmatrix}, \quad \text{or} \quad \begin{cases} A_{11}u_1 + A_{12}u_2 = f_1 \\ A_{21}u_1 + A_{22}u_2 = f_2 \end{cases} \right\}.$$

Note these three expressions are equivalent statements proceeding from the more abstract to the more concrete.

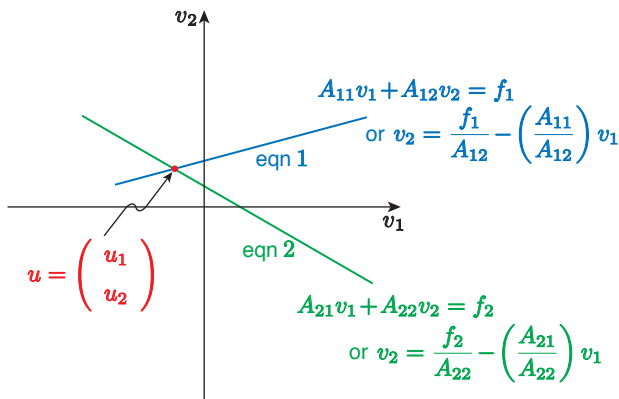

Figure 6: Row perspective: the solution  $u$  is the intersection of two straight lines.

### 3.2 Row View

We first consider the *row* view, similar to the row view of matrix multiplication. In this perspective we consider our solution vector  $u = (u_1 \ u_2)^T$  as a point  $(u_1, u_2)$  in the two dimensional Cartesian plane; a *general* point in the plane is denoted by  $(v_1, v_2)$  corresponding to a vector  $(v_1 \ v_2)^T$ . In particular,  $u$  is the point in the plane which lies both on the straight line described by the first equation,  $(Av)_1 = f_1$ , denoted ‘eqn1’ and shown in Figure 6 in blue, *and* on the straight line described by the second equation,  $(Av)_2 = f_2$ , denoted ‘eqn2’ and shown in Figure 6 in green. (We depict in Figure 6 the case in which  $u$  exists and is unique.)

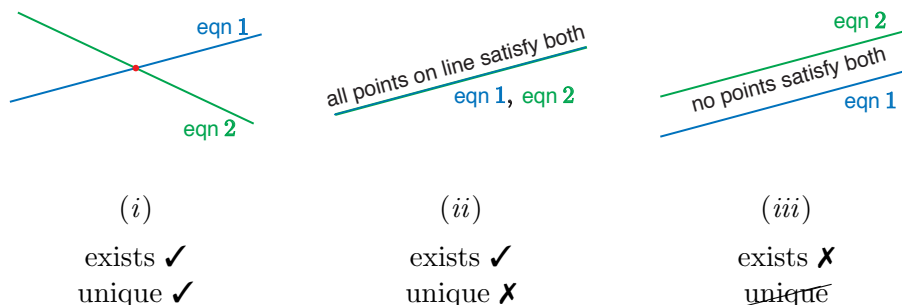

Figure 7: Row perspective: three possibilities for existence and uniqueness.

We directly observe three possibilities, familiar from any first course in algebra; these three cases are shown in Figure 7. In case (i), the two lines are of different slope and there is clearly one and only one intersection: the solution thus exists and is furthermore unique. In case (ii) the two lines are of the same slope and furthermore coincident: a solution exists, but it is not unique — in fact, there are an infinity of solutions. This case corresponds to the situation in which the two equations in fact contain *identical*, hence *redundant*, information. In case (iii) the two lines are of the same slope but *not* coincident: no solution exists (and hence we need not consider uniqueness). This case corresponds to the situation in which the two equations contain *inconsistent* information.

We see that the condition for (both) existence and uniqueness is that the slopes of ‘eqn1’ and ‘eqn2’ must be different. We can summarize this condition in terms of the elements of  $A$ :

$A_{11}/A_{12} \neq A_{21}/A_{22}$ , or

$$A_{11}A_{22} - A_{12}A_{21} \neq 0. \quad (8)$$

(Note the cases  $A_{12} = 0$  or  $A_{22} = 0$  must be considered separately, but we arrive at the same conclusion, (8).) We emphasize that  $Au = f$  has a unique solution if and only if (8) is satisfied: equation (8) is a necessary and sufficient condition for existence and uniqueness.<sup>2</sup> If the condition (8) is not satisfied, then either there is an infinity of solutions, case (ii), or no solution, case (iii).

We close with several necessary and sufficient conditions for existence and uniqueness, all of which can be derived (in our  $2 \times 2$  context) from the condition (8):

1. *The rows of  $A$  are linearly independent.* We denote the first and second row vectors of  $A$  as  $1 \times 2$  vectors  $q^1 \equiv (A_{11} \ A_{12})$  and  $q^2 \equiv (A_{21} \ A_{22})$ , respectively. We note that  $q^1$  and  $q^2$  are linearly independent only if there exists no constant  $c$  such that  $q^1 = cq^2$ . The latter, in turn, is equivalent to the condition  $A_{21}/A_{11} \neq A_{22}/A_{12}$ , which then reduces to (8).
2. *The matrix  $A$  is invertible.*<sup>3</sup> We recall that the inverse of a  $2 \times 2$  matrix  $A$  is given by

$$A^{-1} = \frac{1}{A_{11}A_{22} - A_{12}A_{21}} \begin{pmatrix} A_{22} & -A_{12} \\ -A_{21} & A_{11} \end{pmatrix}. \quad (9)$$

We observe that if and only if (8) is satisfied can we form this inverse. (We may then express our unique solution as  $u = A^{-1}f$ , though in computational practice this formula is rarely invoked.) Some vocabulary: if  $A$  exists, we say that  $A$  is *invertible* or *non-singular*; if  $A^{-1}$  does not exist, we say that  $A$  is *singular*.

3. *The determinant of  $A$  is nonzero.* We recall that the determinant of a  $2 \times 2$  matrix is given by  $\det(A) \equiv A_{11}A_{22} - A_{21}A_{12}$ . Hence  $\det(A) \neq 0$  is equivalent to our condition (8). (The determinant condition is not practical computationally, and serves primarily as a convenient “by hand” check for very small systems.)

If any (and hence, by equivalence, all) of these conditions is not satisfied, then our system  $Au = f$  has either an infinity of solutions or no solution, depending on the particular form of  $f$  relative to  $A$ .

### 3.3 The Column View

We next consider the column view, analogous to the column view of matrix multiplication. In particular, we recall from the column view of matrix-vector multiplication that we can express  $Au$  as

$$Au = \begin{pmatrix} A_{11} & A_{12} \\ A_{21} & A_{22} \end{pmatrix} \begin{pmatrix} u_1 \\ u_2 \end{pmatrix} = \underbrace{\begin{pmatrix} A_{11} \\ A_{21} \end{pmatrix}}_{p^1} u_1 + \underbrace{\begin{pmatrix} A_{12} \\ A_{22} \end{pmatrix}}_{p^2} u_2,$$

<sup>2</sup>We recall that “ $\mathcal{B}$  if  $\mathcal{A}$ ,” or “if  $\mathcal{A}$  then  $\mathcal{B}$ ,” or “ $\mathcal{A} \Rightarrow \mathcal{B}$ ,” indicates that  $\mathcal{A}$  is a sufficient condition for  $\mathcal{B}$  and that  $\mathcal{B}$  is a necessary condition for  $\mathcal{A}$ . It follows that “ $\mathcal{B}$  if and only if  $\mathcal{A}$ ,” or “ $\mathcal{A} \Rightarrow \mathcal{B}$  and  $\mathcal{B} \Rightarrow \mathcal{A}$ ,” or “ $\mathcal{A} \Leftrightarrow \mathcal{B}$ ,” indicates that  $\mathcal{A}$  is a necessary and sufficient condition for  $\mathcal{B}$  (and also *vice versa*):  $\mathcal{A}$  and  $\mathcal{B}$  are equivalent.

<sup>3</sup>A more practical embodiment of this condition, related to the pivots of Gaussian Elimination, is also available.



where  $p^1$  and  $p^2$  are the first and second columns of  $A$ , respectively. Our system of equations can thus be expressed as

$$Au = f \quad \Leftrightarrow \quad p^1 u_1 + p^2 u_2 = f .$$

Thus the question of existence and uniqueness can be stated alternatively: is there a (unique?) combination  $u$  of columns  $p^1$  and  $p^2$  which yields  $f$ ?

We start by answering this question pictorially in terms of the familiar parallelogram construction of the sum of two vectors. To recall the parallelogram construction, we first consider in detail the case shown in Figure 8. We see that in the instance depicted in Figure 8 there is clearly a unique solution: we choose  $u_1$  such that  $f - u_1 p^1$  is parallel to  $p^2$  (there is clearly only one such value of  $u_1$ ); we then choose  $u_2$  such that  $u_2 p^2 = f - u_1 p^1$ .

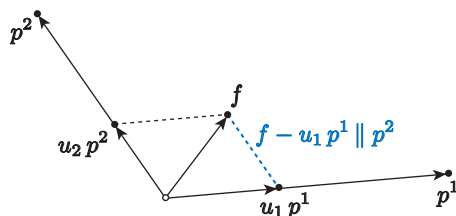

Figure 8: Column perspective: the solution  $u$  is a linear combination of the columns of  $A$ .

We can then identify, in terms of the parallelogram construction, three possibilities; these three cases are shown in Figure 9. Here case (i) is the case already discussed in Figure 8: a unique solution exists. In both cases (ii) and (iii) we note that

$$p^2 = \gamma p^1 \quad \Leftrightarrow \quad p^2 - \gamma p^1 = 0 \quad \Leftrightarrow \quad p^1 \text{ and } p^2 \text{ are linearly dependent}$$

for some scalar  $\gamma$ ; in other words,  $p^1$  and  $p^2$  are colinear — the two vectors *point in the same direction to within a sign* (though  $p^1$  and  $p^2$  may of course be of different magnitude). We now discuss cases (ii) and (iii) in more detail.

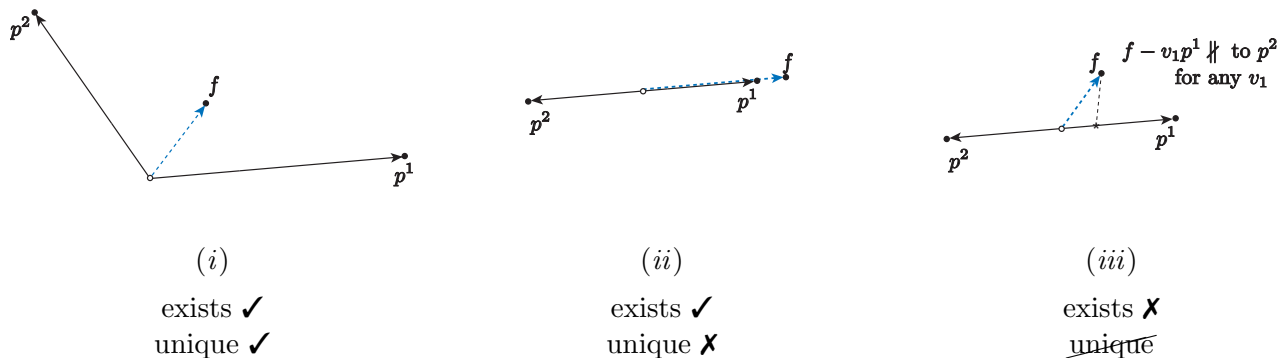

Figure 9: Column perspective: three possibilities for existence and uniqueness.

In case (ii),  $p^1$  and  $p^2$  are colinear, but *also*  $f$  is colinear with  $p^1$  (and  $p^2$ ) — say  $f = \beta p^1$  for

some scalar  $\beta$ . We can thus write

$$\begin{aligned} f &= p^1 \cdot \beta + p^2 \cdot 0 \\ &= \begin{pmatrix} p^1 & p^2 \end{pmatrix} \begin{pmatrix} \beta \\ 0 \end{pmatrix} = \begin{pmatrix} A_{11} & A_{12} \\ A_{21} & A_{22} \end{pmatrix} \underbrace{\begin{pmatrix} \beta \\ 0 \end{pmatrix}}_{u^*} = Au^*, \end{aligned}$$

and hence  $u^*$  is a solution of  $Au = f$ . However, we also know that  $-\gamma p^1 + p^2 = 0$ , and thus

$$\begin{aligned} 0 &= p^1 \cdot (-\gamma) + p^2 \cdot (1) \\ &= \begin{pmatrix} p^1 & p^2 \end{pmatrix} \begin{pmatrix} -\gamma \\ 1 \end{pmatrix} = \begin{pmatrix} A_{11} & A_{12} \\ A_{21} & A_{22} \end{pmatrix} \begin{pmatrix} -\gamma \\ 1 \end{pmatrix} = A \begin{pmatrix} -\gamma \\ 1 \end{pmatrix}. \end{aligned}$$

Thus, for any  $\alpha$ ,

$$u = \underbrace{u^* + \alpha \begin{pmatrix} -\gamma \\ 1 \end{pmatrix}}_{\text{infinity of solutions}}$$

satisfies  $Au = f$ , since

$$\begin{aligned} A \left( u^* + \alpha \begin{pmatrix} -\gamma \\ 1 \end{pmatrix} \right) &= Au^* + A \left( \alpha \begin{pmatrix} -\gamma \\ 1 \end{pmatrix} \right) \\ &= Au^* + \alpha A \begin{pmatrix} -\gamma \\ 1 \end{pmatrix} = f + \alpha \cdot 0 = f. \end{aligned}$$

This demonstrates that in case (ii) there are an infinity of solutions parametrized by the arbitrary constant  $\alpha$ . This makes sense: since  $p^1, p^2$ , and  $f$  are all co-linear, we can represent  $f$  by some multiple of  $p^1$ , some multiple of  $p^2$ , or an infinite number of (the right) combinations of  $p^1$  and  $p^2$ . Note that the vector  $(-\gamma \ 1)^T$  is an eigenvector of  $A$  corresponding to a zero eigenvalue.<sup>4</sup> By definition the matrix  $A$  “has no effect” on an eigenvector associated with a zero eigenvalue, and it is for this reason that if we have one solution to  $Au = f$  then we may add to this solution *any* multiple — here  $\alpha$  — of the zero-eigenvalue eigenvector to obtain yet another solution.

Finally, we consider case (iii). In this case it is clear from our parallelogram construction that for no choice of  $v_1$  will  $f - v_1 p^1$  be parallel to  $p^2$ , and hence for no choice of  $v_2$  can we form  $f - v_1 p^1$  as  $v_2 p^2$ . Put differently, a linear combination of two colinear vectors  $p^1$  and  $p^2$  can not combine to form a vector perpendicular to both  $p^1$  and  $p^2$ . Thus no solution exists.

We now append two new entries to our list of necessary and sufficient conditions for the existence and uniqueness of a solution  $u$  to  $Au = f$ :

---

<sup>4</sup>All scalar multiples of this eigenvector define what is known as the right nullspace of  $A$ .

4. *The columns of  $A$  are independent.* We have already provided the demonstration.
5. *All the eigenvalues of  $A$  are nonzero.* A sketch of the proof:  $A$  can have a zero eigenvalue if and only if the columns of  $A$  are linearly dependent; hence, if  $A$  has no zero eigenvalues, the columns of  $A$  must be linearly independent.

If any (and hence, by equivalence, all) of these conditions is not satisfied, then  $Au = f$  may have either many solutions or no solution, depending on the form of  $f$ . Furthermore, thanks to our column and eigenvector perspectives, we now understand the conditions on  $f$  such that a solution may exist, and the form of the general family of solutions in the case of non-uniqueness.

Finally, we close this section with a very useful sufficient condition for existence: if  $A$  is SPD, then  $Au = f$  has a unique solution. The proof is simple: if  $A$  is SPD, then all the eigenvalues of  $A$  are positive. (Note that SPDicity is, of course, *not* a necessary condition for existence and uniqueness: a matrix need not be SPD to be non-singular.)

**CYAWTP 5.** Revisit the system of springs and masses depicted in Figure 4 and described by the system of equations  $Ku = f$  as formulated in **CYAWTP 1**. Consider the case  $k_1 > 0, k_2 > 0, k_3 > 0$  analyzed in **CYAWTP 3**. Does  $Ku = f$  have a unique solution?

**CYAWTP 6.** Consider the  $2 \times 2$  system of equations  $Au = f$  for

$$A = \begin{pmatrix} 2 & -\frac{1}{2} \\ 1 & \frac{1}{4} \end{pmatrix}. \quad (10)$$

First consider  $f = (1 \ \frac{1}{2})^T$ . Does a solution exist? If so, find the most general form of the solution. Depict  $Au = f$  in terms of the row perspective and also the column perspective: construct figures analogous to Figure 7 and Figure 9, respectively. Now repeat the analysis but for  $f = (1 \ 1)^T$ .

### 3.4 A Tale of Two Springs

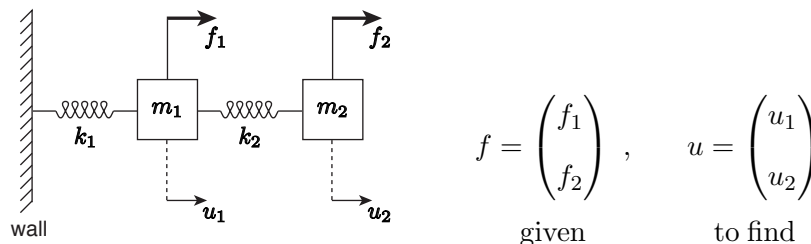

Figure 10: A system of two springs and two masses: given  $f$ , we wish to find  $u$ .

We now interpret our results for existence and uniqueness for a mechanical system — our two springs and masses — to understand the connection between the mathematical model and the theory for existence and uniqueness. We again consider our two masses and two springs, shown in Figure 10, governed by the system of equations

$$Au = f \quad \text{for} \quad A = K \equiv \begin{pmatrix} k_1 + k_2 & -k_2 \\ -k_2 & k_2 \end{pmatrix} \quad \text{for} \quad k_1 \geq 0, k_2 \geq 0. \quad (11)$$

We analyze three different scenarios for the spring constants and forces, denoted (I), (II), and (III), which we will see correspond to cases (i), (ii), and (iii), respectively, as regards existence and uniqueness. We present first (I), then (III), and then (II), as this order is more physically intuitive.

- (I) In scenario (I) we choose  $k_1 = k_2 = 1$  (more physically we would take  $k_1 = k_2 = \bar{k}$  for some value of  $\bar{k}$  expressed in appropriate units — but our conclusions will be the same) and  $f_1 = f_2 = 1$  (more physically we would take  $f_1 = f_2 = \bar{f}$  for some value of  $\bar{f}$  expressed in appropriate units — but our conclusions will be the same). In this case our matrix  $A$  and associated column vectors  $p^1$  and  $p^2$  take the form shown below. It is clear that  $p^1$  and  $p^2$  are not colinear and hence a unique solution exists for any  $f$ . We are in case (i).

$$A = \begin{pmatrix} 2 & -1 \\ -1 & 1 \end{pmatrix} \Rightarrow \begin{array}{c} p^2 = \begin{pmatrix} -1 \\ 1 \end{pmatrix} \\ \nearrow \text{any } f \\ \searrow p^1 = \begin{pmatrix} 2 \\ -1 \end{pmatrix} \end{array}$$

case (i): exists ✓, unique ✓

- (III) In scenario (III) we chose  $k_1 = 0$ ,  $k_2 = 1$  and  $f_1 = f_2 = 1$ . In this case our vector  $f$  and matrix  $A$  and associated column vectors  $p^1$  and  $p^2$  take the form shown below. It is clear that a linear combination of  $p^1$  and  $p^2$  can not possibly represent  $f$  — and hence no solution exists. We are in case (iii).

$$f = \begin{pmatrix} 1 \\ 1 \end{pmatrix}, \quad A = \begin{pmatrix} 1 & -1 \\ -1 & 1 \end{pmatrix} \Rightarrow \begin{array}{c} p^2 \nwarrow \\ \nearrow f \\ \searrow p^1 \end{array}$$

case (iii): exists ✗, ~~unique~~

We can readily identify the cause of the difficulty. For our particular choice of spring constants in scenario (III) the first mass is no longer connected to the wall (since  $k_1 = 0$ ); thus our spring system now appears as in Figure 11. We see that there is a net force on our *system* (of two masses) — the net force is  $f_1 + f_2 = 2 \neq 0$  — and hence it is clearly inconsistent to assume equilibrium.<sup>5</sup> In even greater detail, we see that the equations for each mass are inconsistent with equilibrium (note  $f_{\text{spr}} = k_2(u_2 - u_1)$ ) and hence must be supplemented with respective mass  $\times$  acceleration terms. At fault here is not the mathematics, but rather the model provided for the physical system.

<sup>5</sup>In contrast, in scenario (I), the wall provides the necessary reaction force in order to ensure equilibrium.

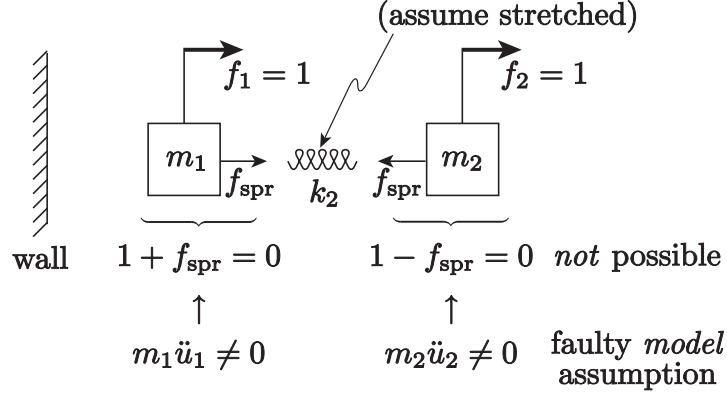
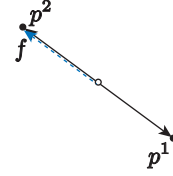

Figure 11: Scenario III: no solution.

(II) In this scenario we choose  $k_1 = 0$ ,  $k_2 = 1$  and  $f_1 = 1, f_2 = -1$ . In this case our vector  $f$  and matrix  $A$  and associated column vectors  $p^1$  and  $p^2$  take the form shown below. It is clear that a linear combination of  $p^1$  and  $p^2$  now *can* represent  $f$  — and in fact there are many possible combinations. We are in case (ii).

$$f = \begin{pmatrix} -1 \\ 1 \end{pmatrix}, \quad A = \begin{pmatrix} 1 & -1 \\ -1 & 1 \end{pmatrix} \Rightarrow$$



case (ii): exists ✓, unique ✗

We can explicitly construct the family of solutions from the general procedure described earlier:

$$p^2 = \underbrace{-1}_{\gamma} p^1, \quad f = \underbrace{-1}_{\beta} p^1 \Rightarrow u^* = \begin{pmatrix} -1 \\ 0 \end{pmatrix},$$

and hence

$$u = u^* + \alpha \begin{pmatrix} -\gamma \\ 1 \end{pmatrix} = \begin{pmatrix} -1 \\ 0 \end{pmatrix} + \alpha \begin{pmatrix} 1 \\ 1 \end{pmatrix}$$

for any  $\alpha$ . Let us check the result explicitly:

$$A \left( \begin{pmatrix} -1 \\ 0 \end{pmatrix} + \begin{pmatrix} \alpha \\ \alpha \end{pmatrix} \right) = \begin{pmatrix} 1 & -1 \\ -1 & 1 \end{pmatrix} \begin{pmatrix} -1 + \alpha \\ \alpha \end{pmatrix} = \begin{pmatrix} (-1 + \alpha) - \alpha \\ (1 - \alpha) + \alpha \end{pmatrix} = \begin{pmatrix} -1 \\ 1 \end{pmatrix} = f,$$

as desired. Note that the zero-eigenvalue eigenvector here is given by  $(-\gamma \ 1)^T = (1 \ 1)^T$  (to within an arbitrary multiplicative constant) and corresponds to an equal translation in both displacements, which we will now interpret physically.

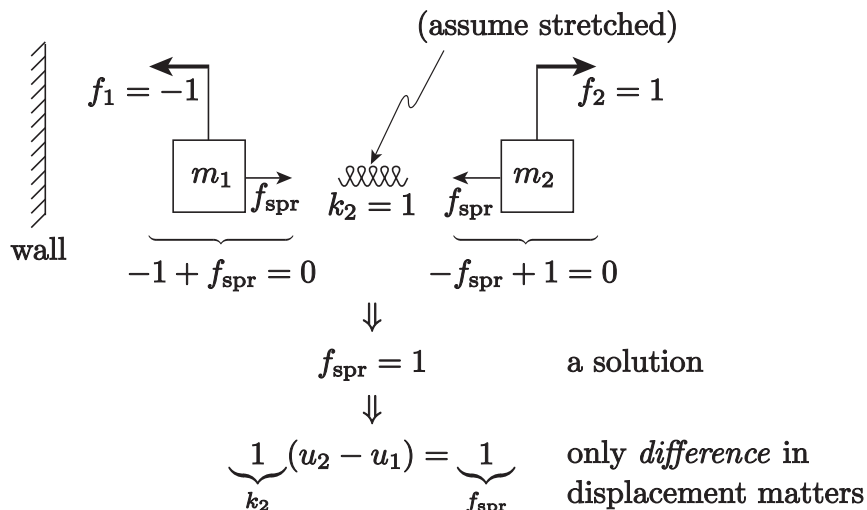

Figure 12: Scenario II: an infinity of solutions. (Note on the left mass the  $f_1$  arrow indicates the direction of the force  $f_1 = -1$ , not the direction of positive force.)

In particular, we can readily identify the cause of the non-uniqueness. For our choice of spring constants in scenario (II) the first mass is no longer connected to the wall (since  $k_1 = 0$ ), just as in scenario (III). Thus our spring system now appears as in Figure 12. But unlike in scenario (III), in scenario (II) the net force on the system is zero —  $f_1$  and  $f_2$  point in opposite directions — and hence an equilibrium is possible. Furthermore, we see that each mass is in equilibrium for a spring force  $f_{spr} = 1$ . Why then is there not a *unique* solution? Because to obtain  $f_{spr} = 1$  we may choose any displacements  $u$  such that  $u_2 - u_1 = 1$  (for  $k_2 = 1$ ): the system is not anchored to wall — it just floats — and thus equilibrium is maintained if we translate both masses by the same displacement (our eigenvector) such that the “stretch”  $u_2 - u_1$  remains invariant. This is illustrated in Figure 13, in which  $\alpha$  is the shift in displacement. Note  $\alpha$  is *not* determined by the *equilibrium* model;  $\alpha$  *could* be determined from a *dynamical* model and in particular would depend on the initial conditions *and* the damping in the system.

**CYAWTP 7.** Show that the matrix  $K$  associated with Scenarios (II) and (III) is not SPD. Find a displacement vector  $v$  for which  $v^T K v = 0$ , and interpret your result in terms of the potential energy of the system.

**CYAWTP 8.** Retell the “Tale” of this section but now in Scenarios (II) and (III) consider spring constants  $k_1 = 1, k_2 = 0$  and applied forces  $f = (-1 \ 0)^T$  in Scenario (II) and  $f = (-1 \ 1)^T$  in Scenario (III). Provide column-perspective sketches of Scenarios (II) and (III) and find, in Scenario (II), the form of the most general solution.

**CYAWTP 9.** Revisit the system of springs and masses depicted in Figure 4 and described by the system of equations  $Ku = f$  as formulated in **CYAWTP 1**. In which of following situations will

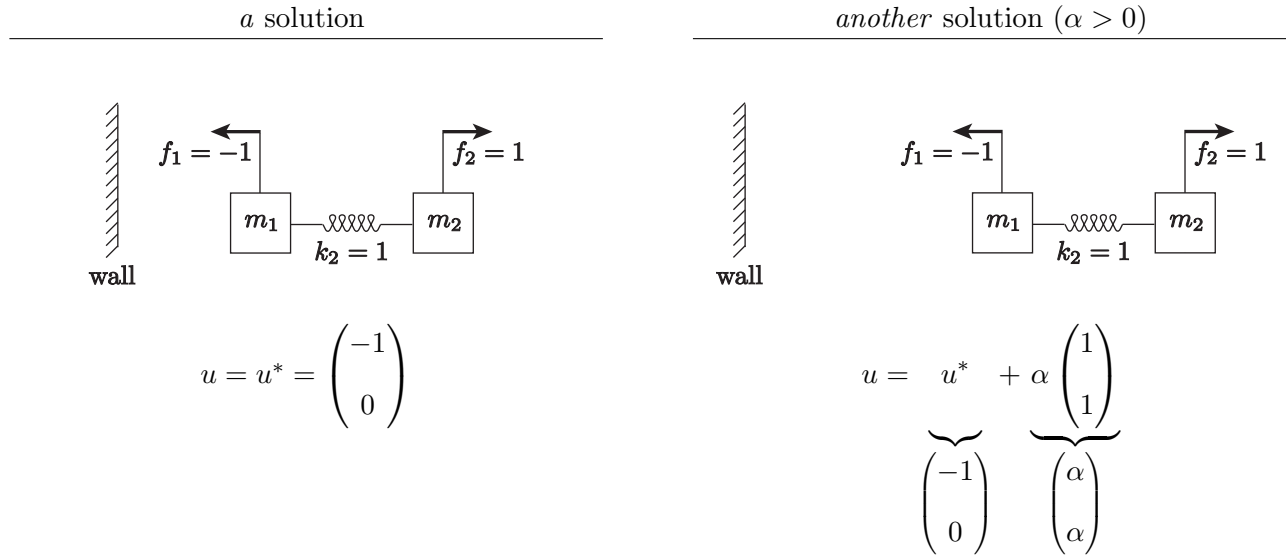

Figure 13: Scenario (II): the origin of non-uniqueness.

$Ku = f$  admit a unique solution:  $k_1 = 0, k_2 > 0, k_3 > 0$ ?  $k_1 > 0, k_2 = 0, k_3 > 0$ ?  $k_1 > 0, k_2 > 0, k_3 = 0$ ?  $k_1 = 0, k_2 > 0, k_3 = 0$ ?

## 4 “Large” Spring-Mass Systems

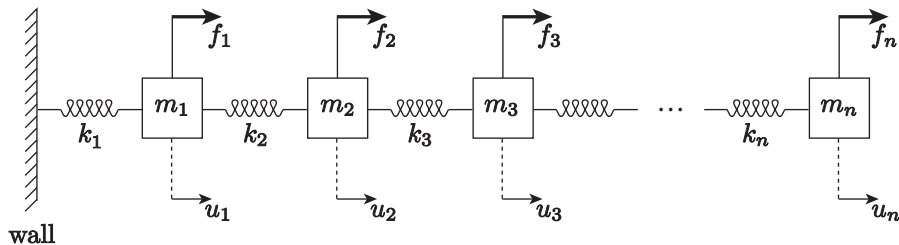

Figure 14: A system of  $n$  springs and  $n$  masses.

We now consider the equilibrium of the system of  $n$  springs and  $n$  masses shown in Figure 14. (This string of springs and masses in fact is a model, or discretization, of a continuum truss; each spring-mass is a small segment of the truss.) Note for  $n = 2$  we recover the small system studied in the preceding sections. This larger system will serve as a more “serious” model problem as regards matrix formation and structure but also existence and uniqueness.

To derive the equations we first consider the force balance on Mass 1,

$$f_1 - k_1 u_1 + k_2(u_2 - u_1) = 0 ,$$

and then on Mass 2,

$$f_2 - k_2(u_2 - u_1) + k_3(u_3 - u_2) = 0 ,$$





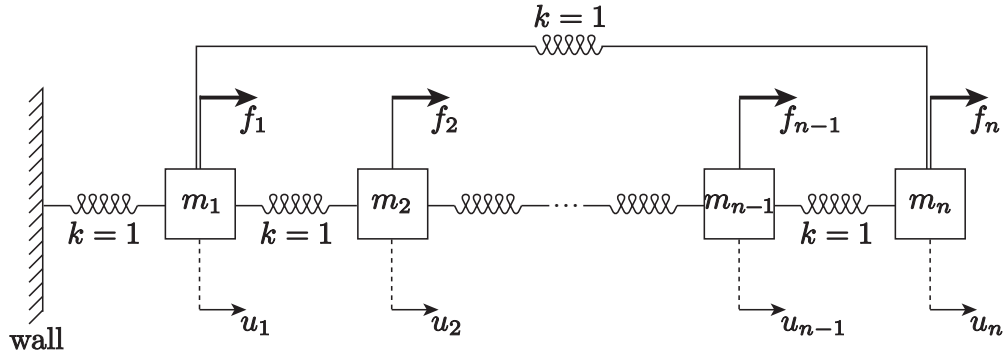

Figure 15: A “cyclic” system of  $n$  springs and masses.

**CYAWTP 10.** Consider the spring-mass system of Figure 15 in which, in addition to the usual nearest-neighbor connections, the first and last masses are also connected: a “cyclic” arrangement. We can form an  $n \times n$  matrix  $K$  and  $n \times 1$  vector  $f$  such that the equilibrium displacement ( $n \times 1$  vector)  $u$  satisfies  $Ku = f$ : for  $i = 1, \dots, n$ , the  $i^{\text{th}}$  equation,  $(Ku)_i = f_i$ , expresses the force balance on Mass  $i$ , where  $(Ku)_i$  refers to the  $i^{\text{th}}$  element of the  $n \times 1$  vector  $Ku$ . Find the entries of the 1<sup>st</sup> row of  $K$  (associated with the force balance on Mass 1). Find the entries of the  $n^{\text{th}}$  row of  $K$  (associated with the force balance on Mass  $n$ ). Find the total number of *nonzero* entries in the matrix  $K$  as a function of  $n$ . Is the matrix  $K$  tri-diagonal? Is the matrix  $K$  symmetric?

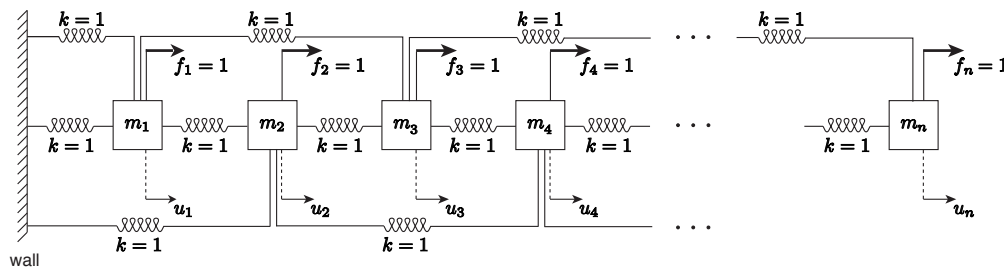

Figure 16: A system of  $n$  springs and masses with nearest-neighbor and also next-to-nearest-neighbor connections.

**CYAWTP 11.** Consider the spring-mass system of Figure 16 in which the springs are connected not only to nearest neighbors but also to next-to-nearest neighbors. We can form an  $n \times n$  matrix  $K$  and  $n \times 1$  vector  $f$  such that the equilibrium displacement ( $n \times 1$  vector)  $u$  satisfies  $Ku = f$ : for  $i = 1, \dots, n$ , the  $i^{\text{th}}$  equation,  $(Ku)_i = f_i$ , expresses the force balance on Mass  $i$ , where  $(Ku)_i$  refers to the  $i^{\text{th}}$  element of the  $n \times 1$  vector  $Ku$ . Find the entries of the 2<sup>nd</sup> row of  $K$  (associated with the force balance on Mass 2). Find the entries of the 3<sup>rd</sup> row of  $K$  (associated with the force balance on Mass 3). The total number of *non-zero* entries in the matrix  $K$  asymptotes to  $Cn$  as  $n \rightarrow \infty$  for some constant  $C$  independent of  $n$ : find  $C$ . (Note since we consider  $n \rightarrow \infty$  you may neglect end effects due to Mass  $n - 1$  and Mass  $n$ .) Is the matrix  $K$  tri-diagonal? Is the matrix  $K$  symmetric?

## 5 Existence and Uniqueness: General Case

We now consider a general (square) system of  $n$  equations in  $n$  unknowns,

$$\underbrace{A}_{\text{given}} \underbrace{u}_{\text{to find}} = \underbrace{f}_{\text{given}}, \quad (12)$$

where  $A$  is  $n \times n$ ,  $u$  is  $n \times 1$ , and  $f$  is  $n \times 1$ . As you might suspect from our argument for the  $2 \times 2$  case, if  $A$  has  $n$  independent columns then  $Au = f$  has a unique solution  $u$  for any  $f$ . If  $A$  does not have  $n$  independent columns, then  $Au = f$  will either have no solution or — if  $f$  has the right form — an infinity of solutions.

**CYAWTP 12.** Consider (12) for the case  $n = 3$ . We denote the three columns of the matrix  $A$  by the  $3 \times 1$  vectors  $p^1, p^2$ , and  $p^3$ , respectively. We shall assume that  $p^1$  and  $p^2$  are independent. In each of the four cases below,

1.  $(p^1 \times p^2) \cdot p^3 \neq 0$  and  $(p^1 \times p^2) \cdot f = 0$ ,
2.  $(p^1 \times p^2) \cdot p^3 \neq 0$  and  $(p^1 \times p^2) \cdot f \neq 0$ ,
3.  $(p^1 \times p^2) \cdot p^3 = 0$  and  $(p^1 \times p^2) \cdot f = 0$ ,
4.  $(p^1 \times p^2) \cdot p^3 = 0$  and  $(p^1 \times p^2) \cdot f \neq 0$ ,

indicate whether  $Au = f$  has a unique solution, no solution, or an infinity of solutions. Provide a sketch of each situation. Note that  $\times$  and  $\cdot$  refer respectively to the cross product and dot product in 3-space.

There are in fact many necessary and sufficient conditions for existence and uniqueness of a solution  $u$  to  $Au = f$ :  $A$  has  $n$  independent columns;  $A$  has  $n$  independent rows;  $A$  is invertible (non-singular);  $A$  has nonzero determinant;  $A$  has no zero eigenvalues. In addition, there is an important sufficient but not necessary condition:  $A$  is SPD. In one or another situation one or another of these conditions might be easier to verify; we need only confirm one necessary or sufficient condition and then all the necessary conditions are perforce satisfied. In the event that any, and hence all, of the necessary conditions are *not* satisfied, then  $Au = f$  will have either no solution or — if  $f$  has the right form — an infinity of solutions. (Note in the computational context we must also understand and accommodate “*nearly*” singular systems.) In short, all of our conclusions for  $n = 2$  directly extend to the case of general  $n$ .

## 6 Perspectives

Our presentation in this nutshell is quite restrictive from both the practical and theoretical perspectives.

From the practical side, we formulate our matrices “by hand.” In actual engineering practice, in particular for larger systems, there are automated procedures by which to construct a system matrix from constituent component matrices. These methods, which go by different names (“stamping,” “direct stiffness assembly,” . . .) in different communities, are applicable to lumped systems as well as discretizations of continuous systems.

From the theoretical perspective, our extrapolation from  $2 \times 2$  systems to  $n \times n$  systems omits many of the subtleties associated with existence and in particular uniqueness. For a complete description of existence and uniqueness, in terms of the four fundamental spaces associated with a matrix, we recommend G Strang, "Introduction to Linear Algebra," 4<sup>th</sup> Edition, Wellesley-Cambridge Press and SIAM, 2009.

MIT OpenCourseWare  
<http://ocw.mit.edu>

2.086 Numerical Computation for Mechanical Engineers  
Fall 2014

For information about citing these materials or our Terms of Use, visit: <http://ocw.mit.edu/terms>.